

### General Description

These P-Channel enhancement mode power field effect transistors are using trench DMOS technology. This advanced technology has been especially tailored to minimize on-state resistance, provide superior switching performance, and withstand high energy pulse in the avalanche and commutation mode. These devices are well suited for high efficiency fast switching applications.

BVDSS	RDSON	ID
-30V	16mΩ	-10A

### Features

- -30V,-10A,  $R_{DS(ON)} = 16m\Omega @ V_{GS} = -10V$
- Fast switching
- Green Device Available
- Suit for -4.5V Gate Drive Applications

### SOP8 Pin Configuration

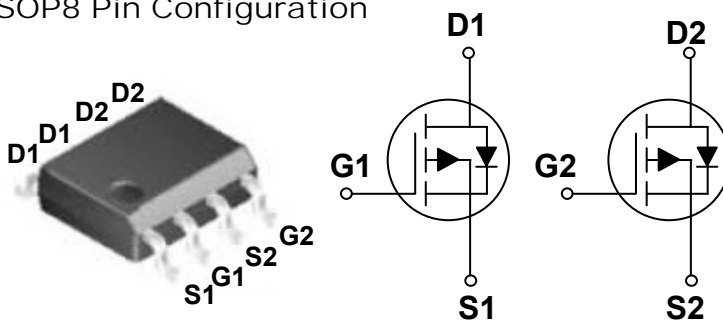

### Applications

- MB / VGA / Vcore
- POL Applications
- Load Switch
- LED Application



### Absolute Maximum Ratings $T_c=25^\circ\text{C}$ unless otherwise noted

Symbol	Parameter	Rating	Units
$V_{DS}$	Drain-Source Voltage	-30	V
$V_{GS}$	Gate-Source Voltage (base on $I_{GSS1}$ condition)	$\pm 20$	V
$V_{GS}$	Gate-Source Voltage (base on $I_{GSS2}$ condition)	$\pm 25$	V
$I_D$	Drain Current – Continuous ( $T_c=25^\circ\text{C}$ )	-10	A
	Drain Current – Continuous ( $T_c=100^\circ\text{C}$ )	-6.3	A
$I_{DM}$	Drain Current – Pulsed <sup>1</sup>	-40	A
$P_D$	Power Dissipation ( $T_c=25^\circ\text{C}$ )	2.1	W
	Power Dissipation – Derate above $25^\circ\text{C}$	0.017	W/ $^\circ\text{C}$
$T_{STG}$	Storage Temperature Range	-55 to 150	$^\circ\text{C}$
$T_J$	Operating Junction Temperature Range	-55 to 150	$^\circ\text{C}$

### Thermal Characteristics

Symbol	Parameter	Typ.	Max.	Unit
$R_{\theta JA}$	Thermal Resistance Junction to ambient	---	60	$^\circ\text{C}/\text{W}$

**Electrical Characteristics ( $T_J=25^\circ\text{C}$ , unless otherwise noted)**
**Off Characteristics**

Symbol	Parameter	Conditions	Min.	Typ.	Max.	Unit
$BV_{DSS}$	Drain-Source Breakdown Voltage	$V_{GS}=0V, I_D=-250\mu A$	-30	---	---	V
$\Delta BV_{DSS}/\Delta T_J$	$BV_{DSS}$ Temperature Coefficient	Reference to $25^\circ\text{C}$ , $I_D=-1\text{mA}$	---	-0.03	---	$V/^\circ\text{C}$
$I_{DSS}$	Drain-Source Leakage Current	$V_{DS}=-30V, V_{GS}=0V, T_J=25^\circ\text{C}$	---	---	-1	$\mu A$
		$V_{DS}=-24V, V_{GS}=0V, T_J=125^\circ\text{C}$	---	---	-10	$\mu A$
$I_{GSS1}$	Gate-Source Leakage Current	$V_{GS}=\pm 20V, V_{DS}=0V$	---	---	$\pm 100$	nA
$I_{GSS2}$	Gate-Source Leakage Current	$V_{GS}=\pm 25V, V_{DS}=0V$	---	---	$\pm 1$	mA

**On Characteristics**

$R_{DS(ON)}$	Static Drain-Source On-Resistance	$V_{GS}=-10V, I_D=-8A$	---	12	16	$m\Omega$
		$V_{GS}=-4.5V, I_D=-6A$	---	18	26	$m\Omega$
$V_{GS(th)}$	Gate Threshold Voltage	$V_{GS}=V_{DS}, I_D=-250\mu A$	-1.2	-1.6	-2.5	V
$\Delta V_{GS(th)}$	$V_{GS(th)}$ Temperature Coefficient		---	4	---	$mV/^\circ\text{C}$
gfs	Forward Transconductance	$V_{DS}=-10V, I_D=-8A$	---	10.5	---	S

**Dynamic and switching Characteristics**

$Q_g$	Total Gate Charge <sup>2,3</sup>	$V_{DS}=-15V, V_{GS}=-4.5V, I_D=-8A$	---	14.6	21	nC
$Q_{gs}$	Gate-Source Charge <sup>2,3</sup>		---	4.1	6	
$Q_{gd}$	Gate-Drain Charge <sup>2,3</sup>		---	6.3	9	
$T_{d(on)}$	Turn-On Delay Time <sup>2,3</sup>	$V_{DD}=-15V, V_{GS}=-10V, R_G=6\Omega$ $I_D=-1A$	---	9	17	ns
$T_r$	Rise Time <sup>2,3</sup>		---	21.8	41	
$T_{d(off)}$	Turn-Off Delay Time <sup>2,3</sup>		---	59.8	114	
$T_f$	Fall Time <sup>2,3</sup>		---	14.4	27	
$C_{iss}$	Input Capacitance	$V_{DS}=-15V, V_{GS}=0V, F=1\text{MHz}$	---	1730	2510	pF
$C_{oss}$	Output Capacitance		---	180	260	
$C_{riss}$	Reverse Transfer Capacitance		---	125	180	

**Drain-Source Diode Characteristics and Maximum Ratings**

Symbol	Parameter	Conditions	Min.	Typ.	Max.	Unit
$I_S$	Continuous Source Current	$V_G=V_D=0V$ , Force Current	---	---	-7	A
$I_{SM}$	Pulsed Source Current		---	---	-14	A
$V_{SD}$	Diode Forward Voltage	$V_{GS}=0V, I_S=-1A, T_J=25^\circ\text{C}$	---	---	-1	V

Note :

1. Repetitive Rating : Pulsed width limited by maximum junction temperature.
2. The data tested by pulsed , pulse width  $\leq 300\mu s$  , duty cycle  $\leq 2\%$ .
3. Essentially independent of operating temperature.

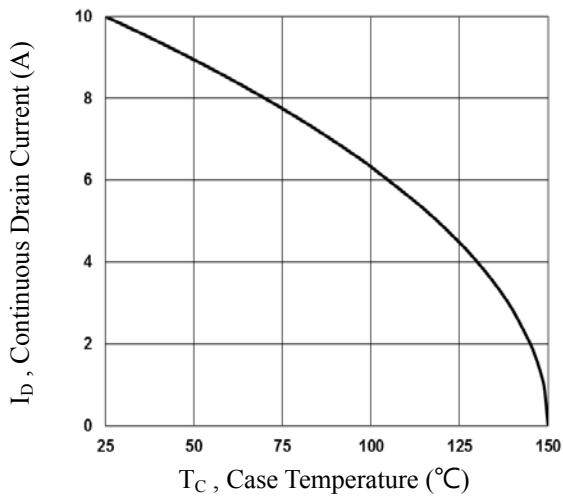

Fig.1 Continuous Drain Current vs.  $T_C$

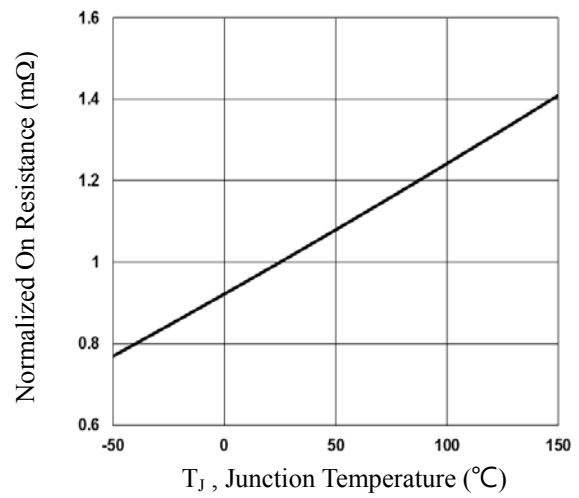

Fig.2 Normalized  $R_{DS(on)}$  vs.  $T_J$

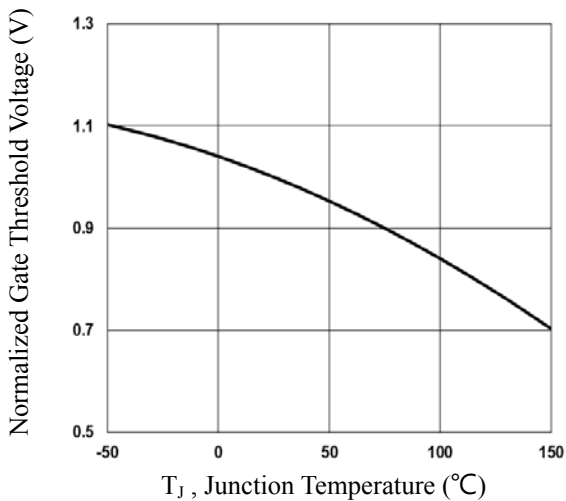

Fig.3 Normalized  $V_{th}$  vs.  $T_J$

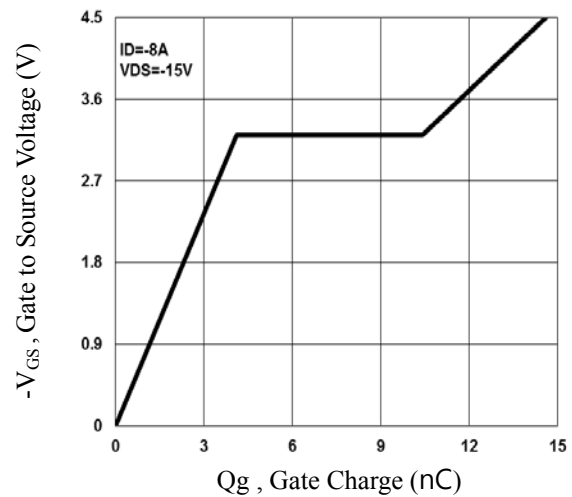

Fig.4 Gate Charge Waveform

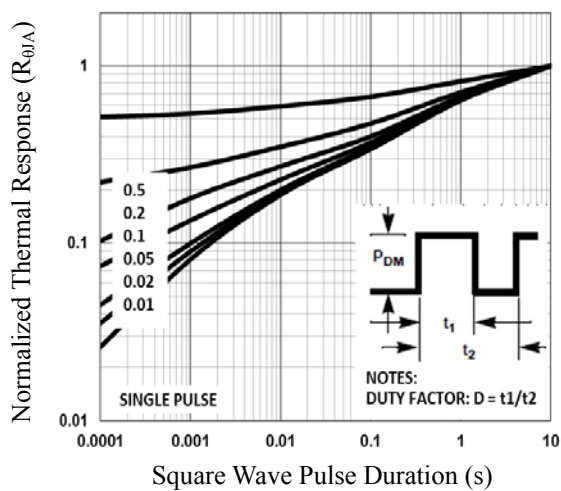

Fig.5 Normalized Transient Impedance

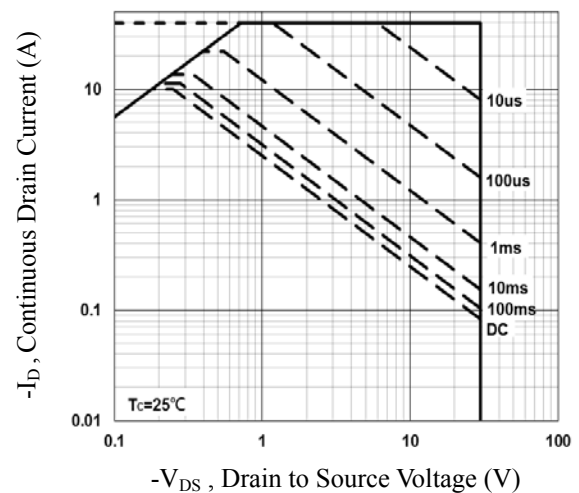

Fig.6 Maximum Safe Operation Area

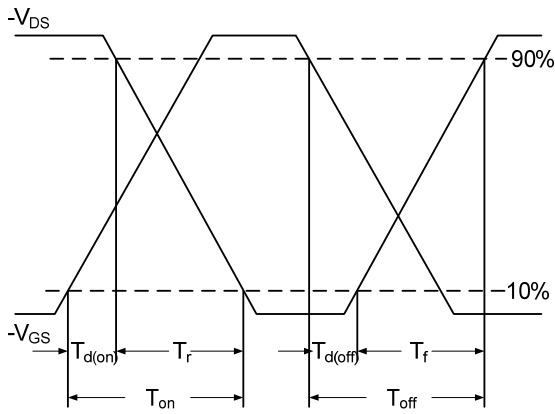

Fig.7 Switching Time Waveform

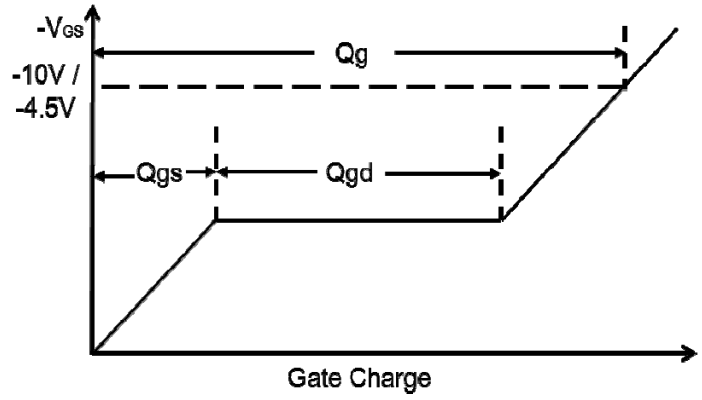
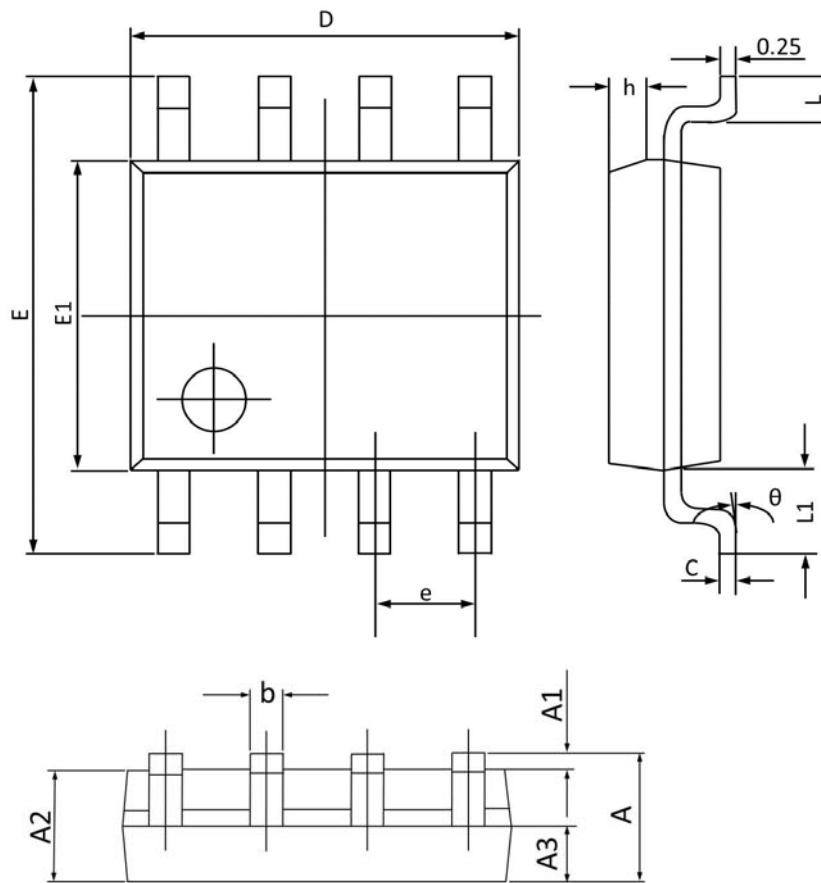

Fig.8 Gate Charge Waveform



## SOP8 PACKAGE INFORMATION



Symbol	Dimensions In Millimeters		Dimensions In Inches	
	Min	Max	Min	Max
A	1.350	1.750	0.053	0.068
A1	0.100	0.250	0.004	0.009
A2	1.300	1.500	0.052	0.059
A3	0.600	0.700	0.024	0.027
b	0.390	0.480	0.016	0.018
c	0.210	0.260	0.009	0.010
D	4.700	5.100	0.186	0.200
E	5.800	6.200	0.229	0.244
E1	3.700	4.100	0.146	0.161
e	1.270(BSC)		0.050(BSC)	
h	0.250	0.500	0.010	0.019
L	0.500	0.800	0.019	0.031
L1	1.050(BSC)		0.041(BSC)	
θ	0°	8°	0°	8°