

General Description

These P-Channel enhancement mode power field effect transistors are using trench DMOS technology. This advanced technology has been especially tailored to minimize on-state resistance, provide superior switching performance, and withstand high energy pulse in the avalanche and commutation mode. These devices are well suited for high efficiency fast switching applications.

BVDSS	RDSON	ID
-60V	48mΩ	-16A

Features

- -60V, -16A, $R_{DS(ON)} = 48m\Omega @ V_{GS} = -10V$
- Improved dv/dt capability
- Fast switching
- 100% EAS Guaranteed
- Green Device Available

TO252 Pin Configuration

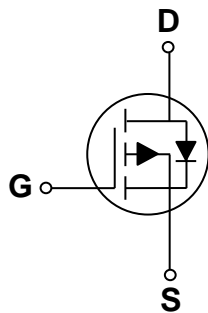
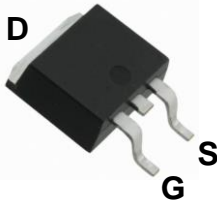

Applications

- Motor Drive
- Power Tools
- LED Lighting



Absolute Maximum Ratings $T_c=25^\circ\text{C}$ unless otherwise noted

Symbol	Parameter	Rating	Units
V_{DS}	Drain-Source Voltage	-60	V
V_{GS}	Gate-Source Voltage	± 20	V
I_D	Drain Current – Continuous ($T_c=25^\circ\text{C}$)	-16	A
	Drain Current – Continuous ($T_c=100^\circ\text{C}$)	-10	A
I_{DM}	Drain Current – Pulsed ¹	-64	A
EAS	Single Pulse Avalanche Energy ²	51	mJ
IAS	Single Pulse Avalanche Current ²	-32	A
P_D	Power Dissipation ($T_c=25^\circ\text{C}$)	25	W
	Power Dissipation – Derate above 25°C	0.2	W/ $^\circ\text{C}$
T_{STG}	Storage Temperature Range	-50 to 150	$^\circ\text{C}$
T_J	Operating Junction Temperature Range	-50 to 150	$^\circ\text{C}$

Thermal Characteristics

Symbol	Parameter	Typ.	Max.	Unit
$R_{\theta JA}$	Thermal Resistance Junction to ambient	---	62	$^\circ\text{C/W}$
$R_{\theta JC}$	Thermal Resistance Junction to Case	---	5	$^\circ\text{C/W}$

Electrical Characteristics ($T_J=25^\circ\text{C}$, unless otherwise noted)
Off Characteristics

Symbol	Parameter	Conditions	Min.	Typ.	Max.	Unit
BV_{DSS}	Drain-Source Breakdown Voltage	$V_{GS}=0V, I_D=-250\mu A$	-60	---	---	V
$\Delta BV_{DSS}/\Delta T_J$	BV_{DSS} Temperature Coefficient	Reference to 25°C , $I_D=-1\text{mA}$	---	-0.05	---	$V/^\circ\text{C}$
I_{DSS}	Drain-Source Leakage Current	$V_{DS}=-60V, V_{GS}=0V, T_J=25^\circ\text{C}$	---	---	-1	μA
		$V_{DS}=-48V, V_{GS}=0V, T_J=125^\circ\text{C}$	---	---	-10	μA
I_{GSS}	Gate-Source Leakage Current	$V_{GS}=\pm 20V, V_{DS}=0V$	---	---	± 100	nA

On Characteristics

$R_{DS(ON)}$	Static Drain-Source On-Resistance	$V_{GS}=-10V, I_D=-8A$	---	39	48	$m\Omega$
		$V_{GS}=-4.5V, I_D=-4A$	---	53	65	$m\Omega$
$V_{GS(th)}$	Gate Threshold Voltage	$V_{GS}=V_{DS}, I_D=-250\mu A$	-1.2	-1.6	-2.2	V
$\Delta V_{GS(th)}$	$V_{GS(th)}$ Temperature Coefficient		---	5	---	$mV/^\circ\text{C}$
gfs	Forward Transconductance	$V_{DS}=-10V, I_D=-8A$	---	10	---	S

Dynamic and switching Characteristics

Q_g	Total Gate Charge ^{3, 4}	$V_{DS}=-30V, V_{GS}=-10V, I_D=-8A$	---	22.4	31	nC
Q_{gs}	Gate-Source Charge ^{3, 4}		---	4.1	6	
Q_{gd}	Gate-Drain Charge ^{3, 4}		---	5.2	7	
$T_{d(on)}$	Turn-On Delay Time ^{3, 4}	$V_{DD}=-30V, V_{GS}=-10V, R_G=6\Omega$ $I_D=-1A$	---	13	25	ns
T_r	Rise Time ^{3, 4}		---	42.4	81	
$T_{d(off)}$	Turn-Off Delay Time ^{3, 4}		---	64.6	123	
T_f	Fall Time ^{3, 4}		---	16.4	31	
C_{iss}	Input Capacitance	$V_{DS}=-30V, V_{GS}=0V, F=1\text{MHz}$	---	1250	1810	pF
C_{oss}	Output Capacitance		---	85	125	
C_{rss}	Reverse Transfer Capacitance		---	65	95	
R_g	Gate resistance		$V_{GS}=0V, V_{DS}=0V, F=1\text{MHz}$	---	15	

Drain-Source Diode Characteristics and Maximum Ratings

Symbol	Parameter	Conditions	Min.	Typ.	Max.	Unit
I_S	Continuous Source Current	$V_G=V_D=0V$, Force Current	---	---	-16	A
I_{SM}	Pulsed Source Current		---	---	-64	A
V_{SD}	Diode Forward Voltage	$V_{GS}=0V, I_S=-1A, T_J=25^\circ\text{C}$	---	---	-1	V
t_{rr}	Reverse Recovery Time ³	$V_{GS}=0V, I_S=-1A, di/dt=100A/\mu s$	---	---	---	ns
Q_{rr}	Reverse Recovery Charge ³	$T_J=25^\circ\text{C}$	---	---	---	nC

Note :

1. Repetitive Rating : Pulsed width limited by maximum junction temperature.
2. $V_{DD}=-25V, V_{GS}=-10V, L=0.1\text{mH}, I_{AS}=-32A, R_G=25\Omega$, Starting $T_J=25^\circ\text{C}$
3. The data tested by pulsed, pulse width $\leq 300\mu s$, duty cycle $\leq 2\%$.
4. Essentially independent of operating temperature.

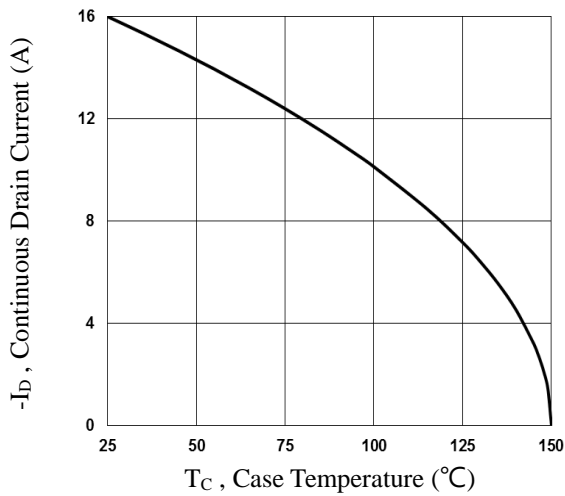

Fig.1 Continuous Drain Current vs. T_c

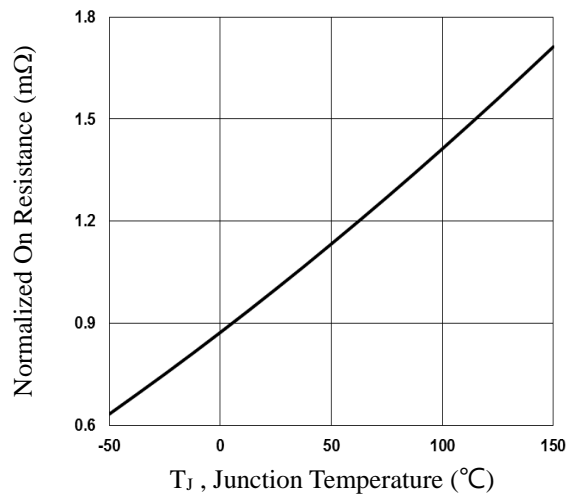

Fig.2 Normalized $R_{DS(on)}$ vs. T_j

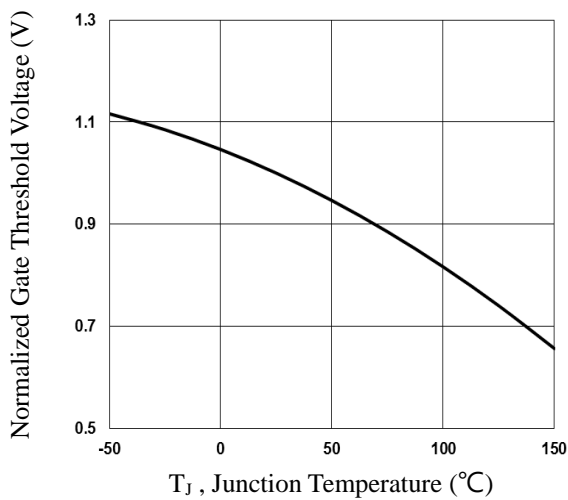

Fig.3 Normalized V_{th} vs. T_j

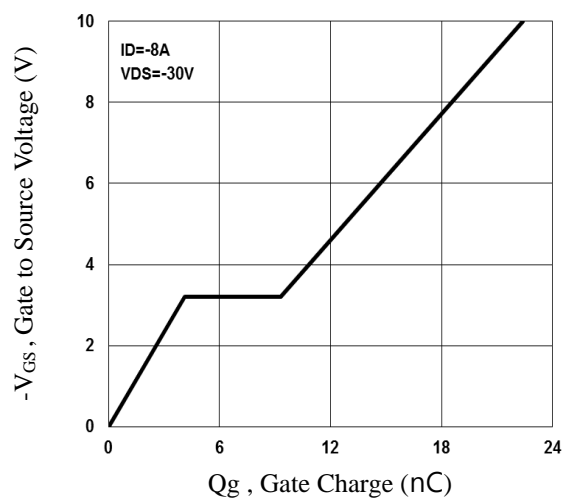

Fig.4 Gate Charge Waveform

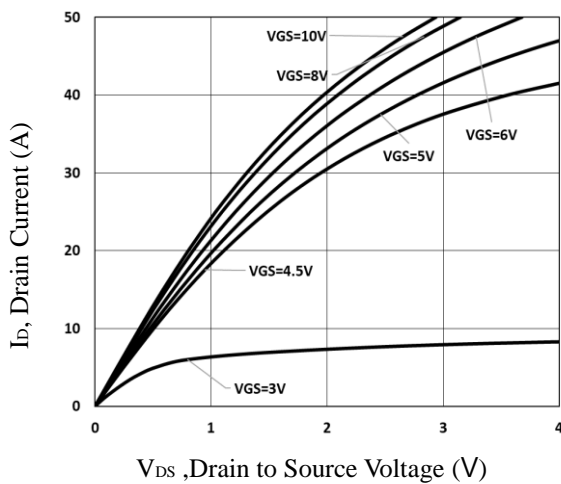

Fig.5 Typical Output Characteristics

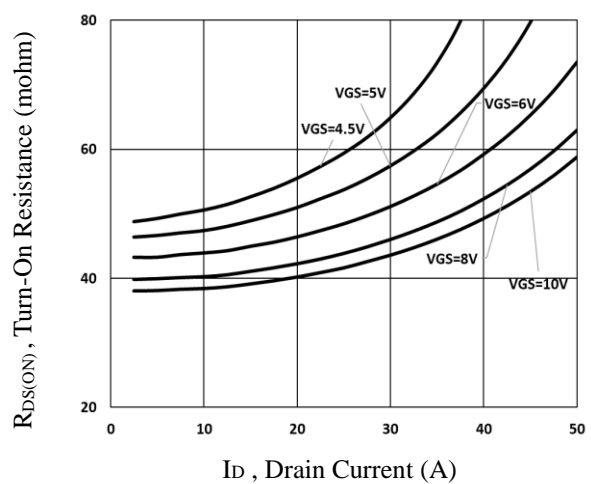

Fig.6 Turn-On Resistance vs. I_D

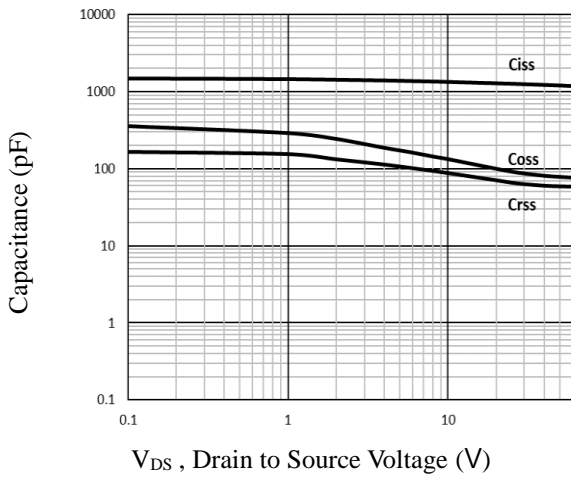

Fig.7 Capacitance Characteristics

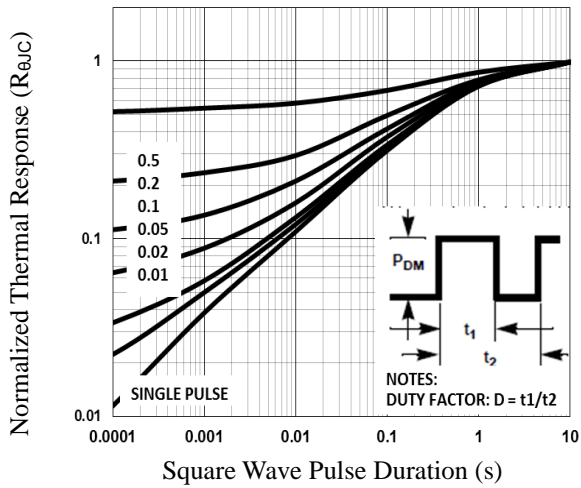

Fig.8 Normalized Transient Impedance

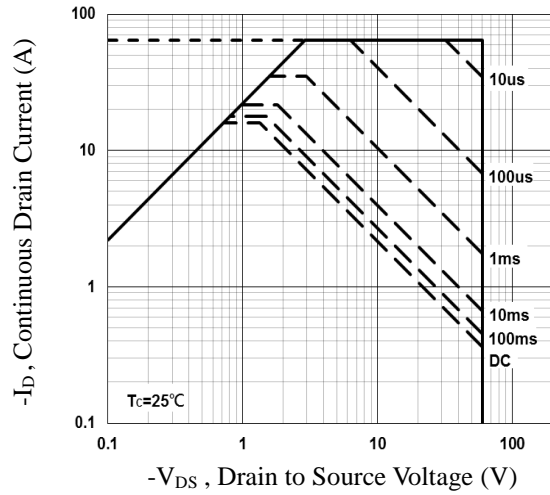

Fig.9 Maximum Safe Operation Area

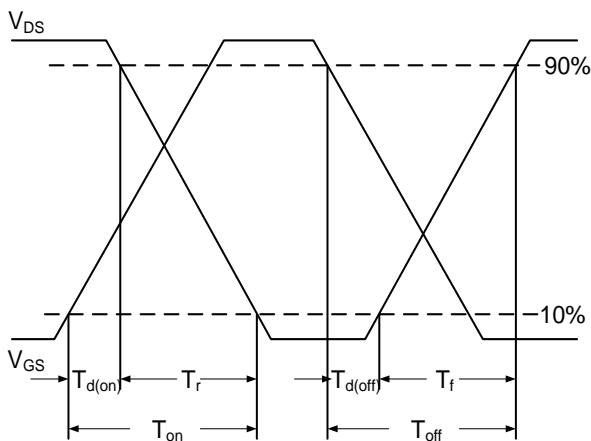

Fig.10 Switching Time Waveform

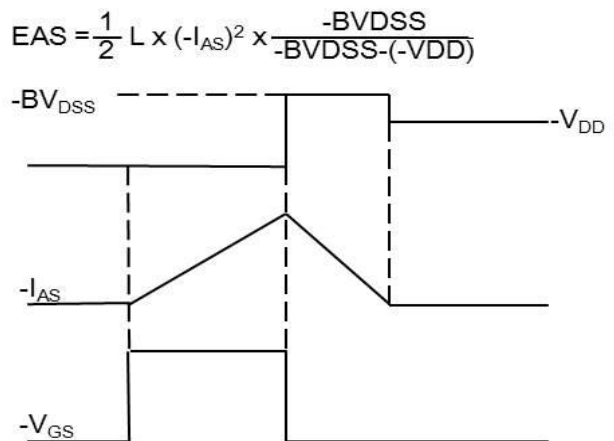
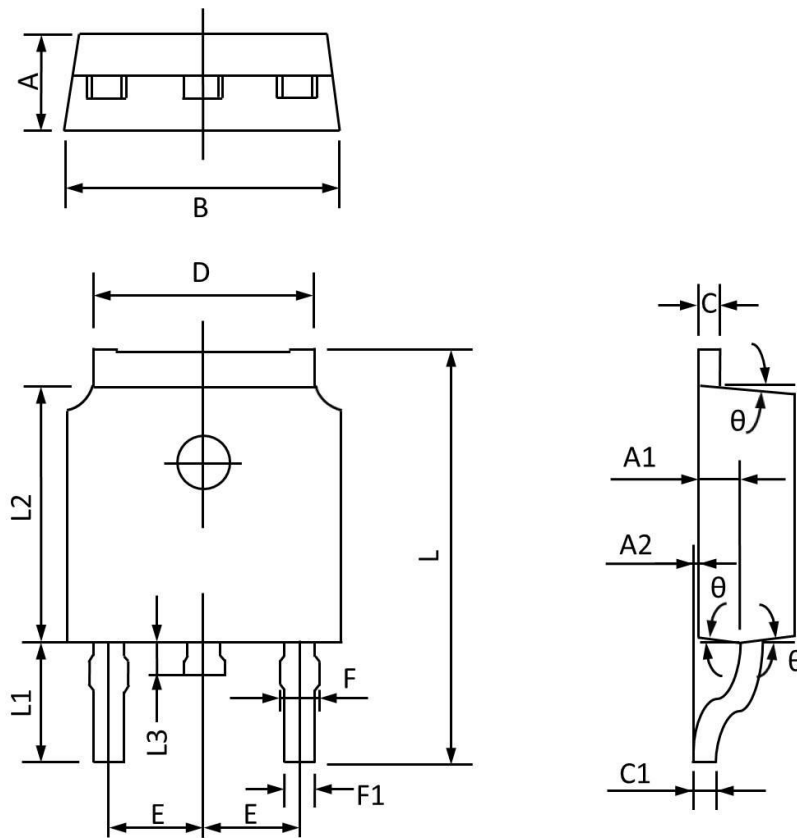

Fig.11 EAS Waveform



TO252 PACKAGE INFORMATION



Symbol	Dimensions In Millimeters		Dimensions In Inches	
	Min	Max	Min	Max
A	2.20	2.40	0.087	0.094
A1	0.91	1.11	0.036	0.044
A2	0.00	0.15	0.000	0.006
B	6.50	6.70	0.256	0.264
C	0.46	0.580	0.018	0.230
C1	0.46	0.580	0.018	0.030
D	5.10	5.46	0.201	0.215
E	2.186	2.386	0.086	0.094
F	0.74	0.94	0.029	0.037
F1	0.660	0.860	0.026	0.034
L	9.80	10.40	0.386	0.409
L1	2.9REF		0.114REF	
L2	6.00	6.20	0.236	0.244
L3	0.60	1.00	0.024	0.039
θ	3°	9°	3°	9°



RECOMMEND FOOTPRINT INFORMATION

