

General Description

These N-Channel enhancement mode power field effect transistors are using trench DMOS technology. This advanced technology has been especially tailored to minimize on-state resistance, provide superior switching performance, and withstand high energy pulse in the avalanche and commutation mode. These devices are well suited for high efficiency fast switching applications.

	BVDSS	RDSON	ID
Q1	30V	9mΩ	55A
Q2	30V	6mΩ	80A



Features

- Improved dv/dt capability
- Fast switching
- 100% EAS Guaranteed
- Green Device Available

PPAK5x6 Asymmetric Dual Pin Configuration

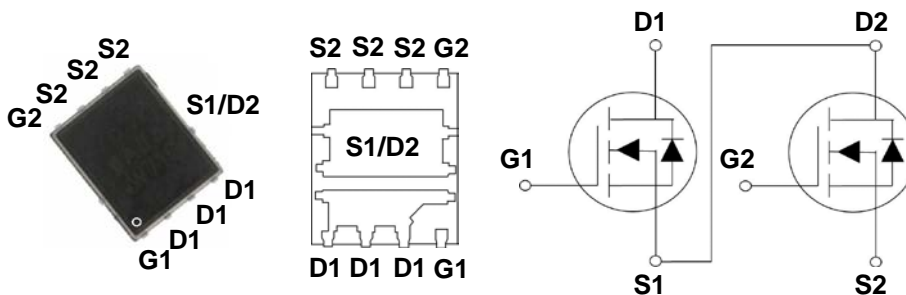

Applications

- MB / VGA / Vcore
- POL Buck Applications
- SMPS 2nd SR

Absolute Maximum Ratings $T_c=25^\circ\text{C}$ unless otherwise noted

Symbol	Parameter	Q1	Q2	Units
V_{DS}	Drain-Source Voltage	30	30	V
V_{GS}	Gate-Source Voltage	± 20	± 20	V
I_D	Drain Current – Continuous ($T_C=25^\circ\text{C}$) , Chip/Package Limit	55/10	80/15	A
	Drain Current – Continuous ($T_C=100^\circ\text{C}$) , Chip/Package Limit	35/6	51/9	A
I_{DM}	Drain Current – Pulsed ¹ , Chip/Package Limit	220/40	320/60	A
EAS	Single Pulse Avalanche Energy ²	45	88	mJ
IAS	Single Pulse Avalanche Current ²	30	42	A
P_D	Power Dissipation ($T_C=25^\circ\text{C}$)	40	54	W
	Power Dissipation – Derate above 25°C	0.32	0.43	W/ $^\circ\text{C}$
T_{STG}	Storage Temperature Range	-55 to 150		$^\circ\text{C}$
T_J	Operating Junction Temperature Range	-55 to 150		$^\circ\text{C}$

Thermal Characteristics

Symbol	Parameter	Typ.	Max.	Unit
$R_{\theta JA}$ Q1	Thermal Resistance Junction to ambient	---	62	$^\circ\text{C}/\text{W}$
$R_{\theta JA}$ Q2		---	62	$^\circ\text{C}/\text{W}$
$R_{\theta JC}$ Q1	Thermal Resistance Junction to Case	'---	3.1	$^\circ\text{C}/\text{W}$
$R_{\theta JC}$ Q2		'---	2.3	$^\circ\text{C}/\text{W}$

Electrical Characteristics ($T_J=25\text{ }^\circ\text{C}$, unless otherwise noted)
Static State Characteristics

Symbol	Parameter	Conditions		Min.	Typ.	Max.	Unit
BV_{DSS}	Drain-Source Breakdown Voltage	$V_{GS}=0V, I_D=250\mu A$	Q1	30	---	---	V
			Q2	30	---	---	V
$\Delta BV_{DSS}/\Delta T_J$	BV_{DSS} Temperature Coefficient	Reference to 25°C , $I_D=1\text{mA}$	Q1	---	0.04	---	$V/^\circ\text{C}$
			Q2	---	0.04	---	$V/^\circ\text{C}$
I_{DSS}	Drain-Source Leakage Current	$V_{DS}=30V, V_{GS}=0V, T_J=25^\circ\text{C}$	Q1	---	---	1	μA
			Q2	---	---	1	μA
		$V_{DS}=24V, V_{GS}=0V, T_J=125^\circ\text{C}$	Q1	---	---	10	μA
			Q2	---	---	10	μA
I_{GSS}	Gate-Source Leakage Current	$V_{GS}=\pm 20V, V_{DS}=0V$	Q1	---	---	± 100	nA
			Q2	---	---	± 100	nA
$R_{DS(ON)}$	Static Drain-Source On-Resistance ³	$V_{GS}=10V, I_D=8A$	Q1	---	7.5	9	$\text{m}\Omega$
		$V_{GS}=10V, I_D=12A$	Q2	---	4.8	6	$\text{m}\Omega$
		$V_{GS}=4.5V, I_D=5A$	Q1	---	10	13	$\text{m}\Omega$
		$V_{GS}=4.5V, I_D=8A$	Q2	---	6.5	9	$\text{m}\Omega$
$V_{GS(th)}$	Gate Threshold Voltage	$V_{GS}=V_{DS}, I_D=250\mu A$	Q1	1	1.6	2.5	V
			Q2	1	1.6	2.5	V
$\Delta V_{GS(th)}$	$V_{GS(th)}$ Temperature Coefficient	$V_{GS}=V_{DS}, I_D=250\mu A$	Q1	---	-4	---	$\text{mV}/^\circ\text{C}$
			Q2	---	-4	---	$\text{mV}/^\circ\text{C}$
gfs	Forward Transconductance	$V_{DS}=10V, I_D=8A$	Q1	---	14	---	S
		$V_{DS}=10V, I_D=10A$	Q2	---	18	---	S

Dynamic Characteristics

Q_g	Total Gate Charge ^{3,4}	$V_{DS}=15V, V_{GS}=4.5V, I_D=20A$	Q1	---	7.5	---	nC
			Q2	---	11.1	---	
Q_{gs}	Gate-Source Charge ^{3,4}		Q1	---	1.3	---	
			Q2	---	1.85	---	
Q_{gd}	Gate-Drain Charge ^{3,4}		Q1	---	4.5	---	
			Q2	---	6.8	---	
$T_{d(on)}$	Turn-On Delay Time ^{3,4}	$V_{DD}=15V, V_{GS}=10V, R_G=3.3\Omega, I_D=15A$	Q1	---	4.8	---	ns
			Q2	---	7.5	---	
T_r	Rise Time ^{3,4}		Q1	---	12.5	---	
			Q2	---	14.5	---	
$T_{d(off)}$	Turn-Off Delay Time ^{3,4}		Q1	---	27.6	---	
			Q2	---	35.2	---	
T_f	Fall Time ^{3,4}		Q1	---	8.2	---	
			Q2	---	9.6	---	

C _{iss}	Input Capacitance	V _{DS} =25V , V _{GS} =0V , F=1MHz	Q1	---	750	---	pF
			Q2	---	1160	---	
C _{oss}	Output Capacitance		Q1	---	150	---	
			Q2	---	200	---	
C _{rss}	Reverse Transfer Capacitance		Q1	---	110	---	
			Q2	---	180	---	
R _g	Gate resistance	V _{GS} =0V, V _{DS} =0V, F=1MHz	Q1	---	2.7	---	Ω
			Q2	---	2.5	---	Ω

Guaranteed Avalanche Energy

Symbol	Parameter	Conditions	Min.	Typ.	Max.	Unit	
EAS	Single Pulse Avalanche Energy	V _{DD} =25V, L=0.1mH, I _{AS} =15A	Q1	12	---	---	mJ
			Q2	20	---	---	mJ

Drain-Source Diode Characteristics

Symbol	Parameter	Conditions	Min.	Typ.	Max.	Unit		
I _s	Continuous Source Current	V _G =V _D =0V , Force Current	Q1	---	---	55	A	
			Q2	---	---	80	A	
I _{SM}	Pulsed Source Current ³		Q1	---	---	220	A	
			Q2	---	---	320	A	
V _{SD}	Diode Forward Voltage ³		V _{GS} =0V , I _S =1A , T _J =25°C	Q1	---	---	1	V
				Q2	---	---	1	V
t _{rr}	Reverse Recovery Time	V _{GS} =0V, I _S =1A , di/dt=100A/μs T _J =25°C		Q1	---	---	---	ns
				Q2	---	---	---	ns
Q _{rr}	Reverse Recovery Charge			Q1	---	---	---	nC
				Q2	---	---	---	nC

Note :

1. Repetitive Rating : Pulsed width limited by maximum junction temperature.
2. V_{DD}=25V, V_{GS}=10V, L=0.1mH, Q1: I_{AS}=30A, Q2: I_{AS}=42A, R_G=25Ω, Starting T_J=25°C.
3. The data tested by pulsed , pulse width ≤ 300us , duty cycle ≤ 2%.
4. Essentially independent of operating temperature.

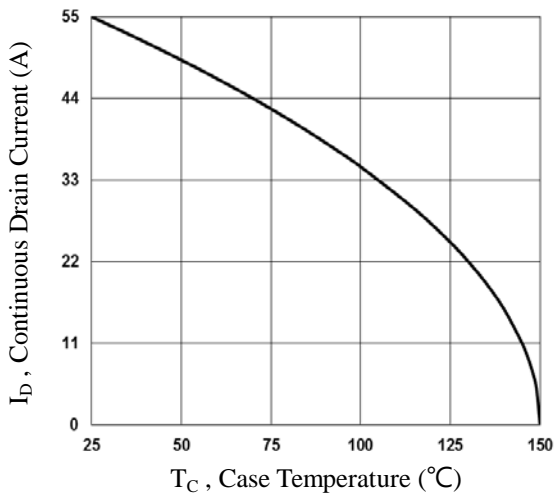

Fig.1 Q1 Continuous Drain Current vs. T_c

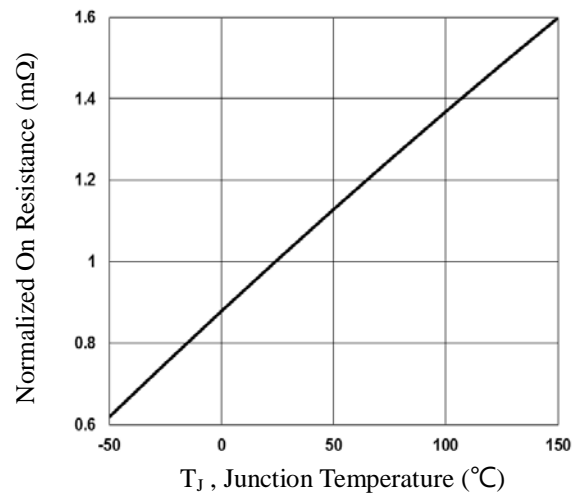

Fig.2 Q1 Normalized $R_{DS(on)}$ vs. T_j

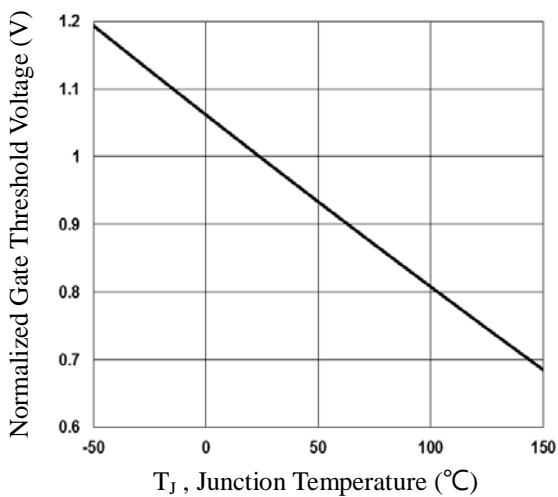

Fig.3 Q1 Normalized V_{th} vs. T_j

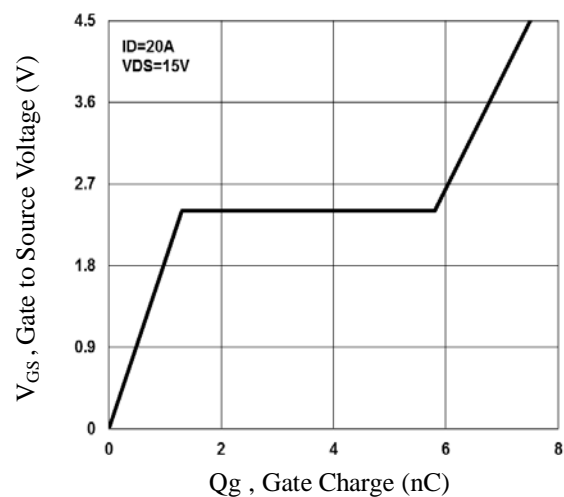

Fig.4 Q1 Gate Charge Waveform

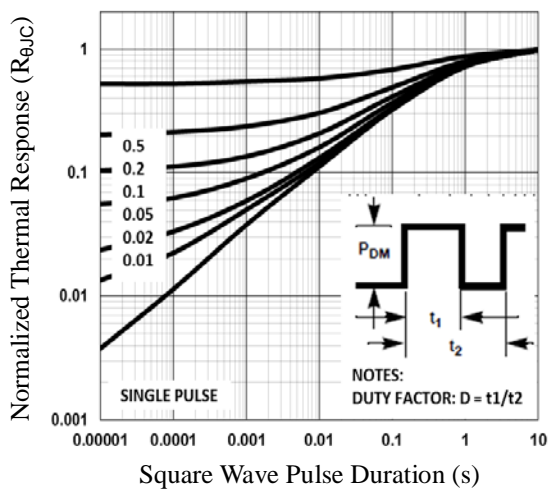

Fig.5 Q1 Normalized Transient Impedance

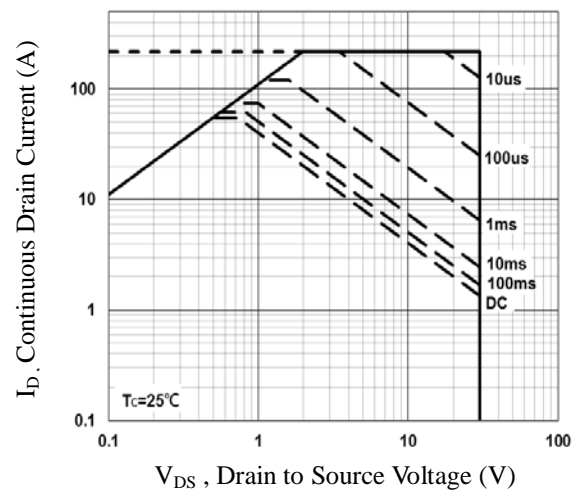

Fig.6 Q1 Maximum Safe Operation Area

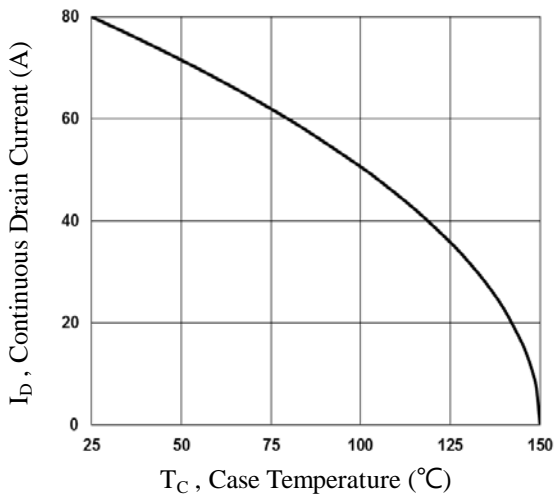

Fig. 7 Q2 Continuous Drain Current vs. T_C

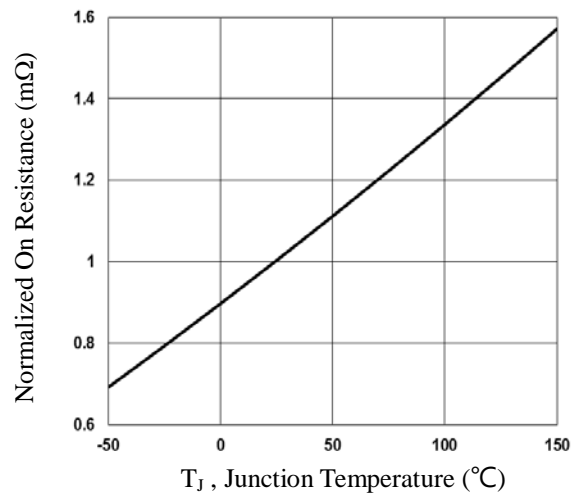

Fig. 8 Q2 Normalized $R_{DS(on)}$ vs. T_J

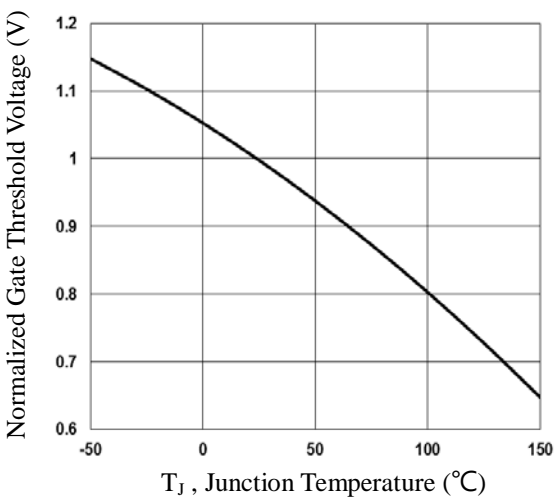

Fig. 9 Q2 Normalized V_{th} vs. T_J

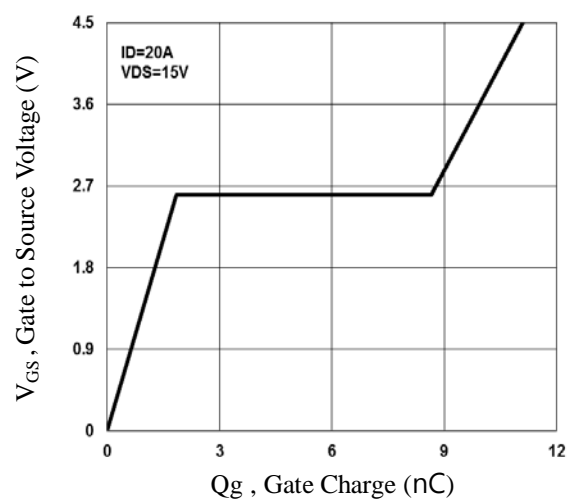

Fig. 10 Q2 Gate Charge Waveform

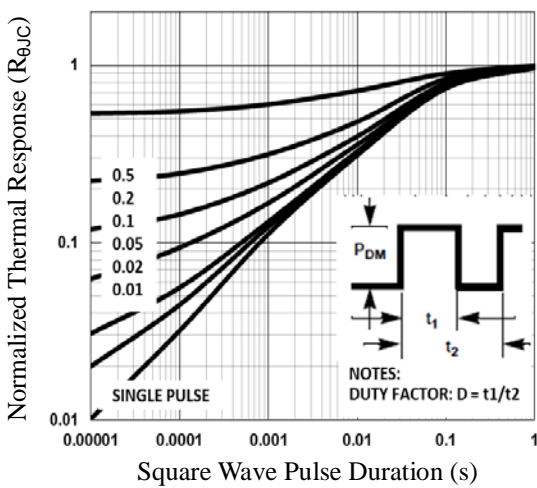

Fig. 11 Q2 Normalized Transient Impedance

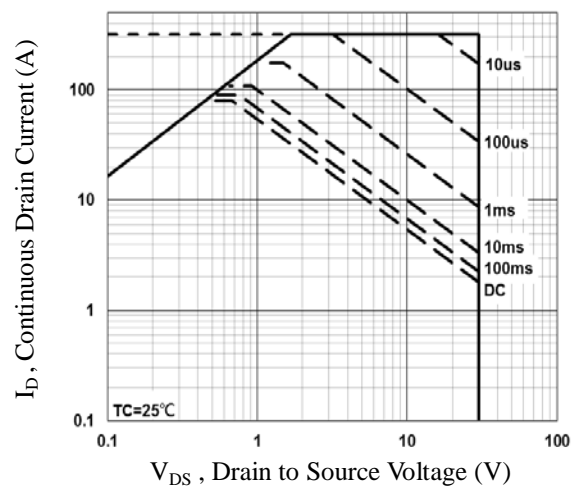

Fig. 12 Q2 Maximum Safe Operation Area

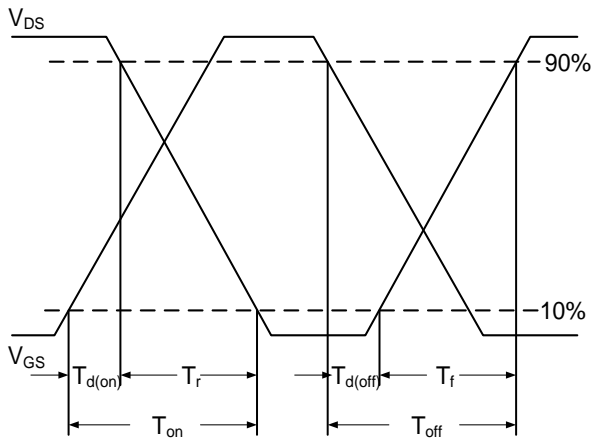

Fig.13 Switching Time Waveform

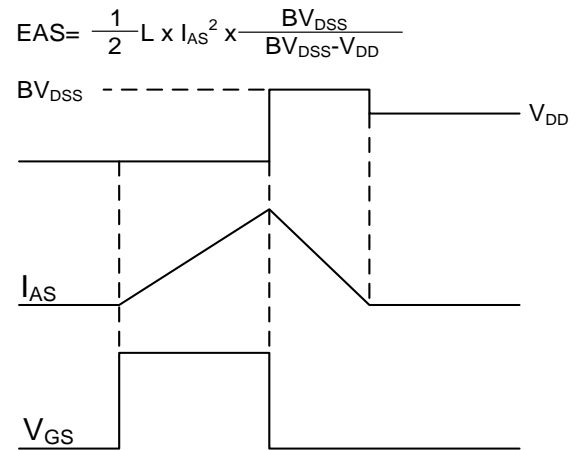
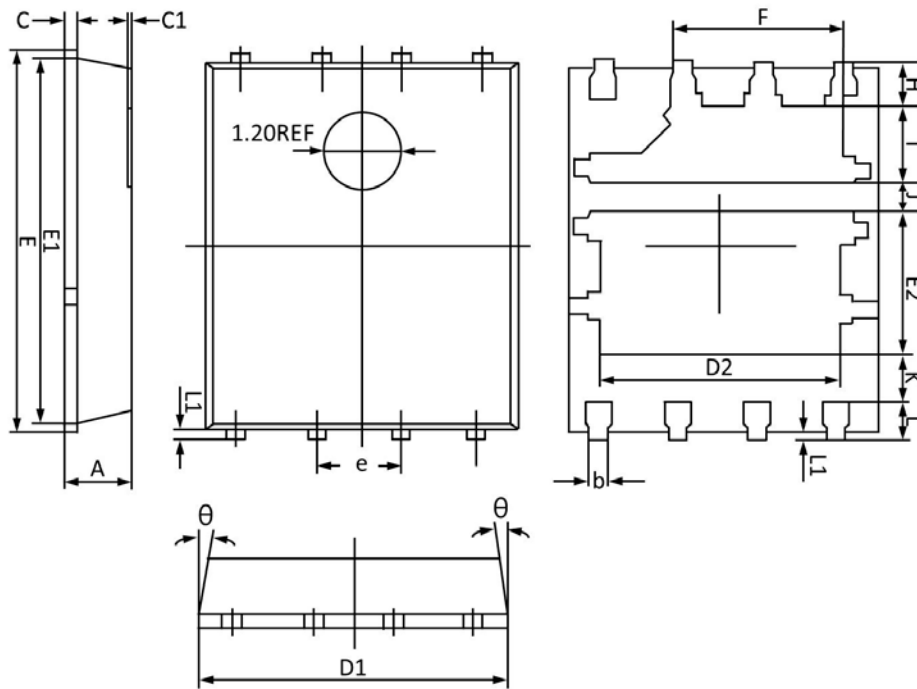

Fig.14 EAS Waveform



PPAK5x6 Asymmetric Dual Package Information



Symbol	Dimensions In Millimeters		Dimensions In Inches	
	Min	Max	Min	Max
A	0.900	1.100	0.036	0.043
b	0.330	0.510	0.013	0.020
C	0.200	0.300	0.008	0.011
C1	0.040 REF		0.040 REF	
D1	4.800	5.000	0.189	0.196
D2	3.610	3.960	0.143	0.155
E	5.900	6.100	0.233	0.240
E1	5.700	5.800	0.225	0.228
E2	2.020	2.420	0.080	0.095
e	1.270BSC		1.270BSC	
F	2.550	2.900	0.101	0.114
H	0.610	0.810	0.025	0.031
I	1.100	1.300	0.044	0.051
J	0.400	0.600	0.016	0.023
K	0.500	-	0.020	-
L	0.510	0.710	0.020	0.027
L1	0.060	0.200	0.003	0.007
θ	0°	12°	0°	12°