

Features

- Low forward voltage drop
- High junction temperature
- Moisture sensitivity: level 1, per J-STD-020
- Plastic package has underwriters laboratory flammability classification 94V-0
- Add suffix 'E' for halogen-free
- Halogen-free according to IEC 61249-2-21 definition

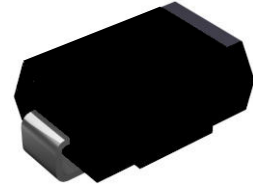

Package: DO-214AB (SMC)

Applications

For use in low voltage, high frequency inverters, free wheeling and polarity protection applications.



Maximum Ratings (T_A = 25°C unless otherwise noted)

Parameter	Symbol	SK5C0C SK5C0CE	Unit
Maximum Repetitive Peak Reverse Voltage	V _{RRM}	200	V
Maximum RMS Voltage	V _{RMS}	140	V
Maximum DC Blocking Voltage	V _{DC}	200	V
Maximum Average Forward Rectified Current	I _{F(AV)}	5.0	A
Peak Forward Surge Current (8.3 ms single half sine-wave superimposed on rated load)	I _{FSM}	120	A
Operating Junction and Storage Temperature Range	T _J , T _{STG}	-55 to +150	°C

Electrical Characteristics (T_A = 25°C unless otherwise noted)

Parameter	Test Conditions	Symbol	Value	Unit
Maximum Instantaneous Forward Voltage	I _F =5A	V _F	0.85	V
Maximum DC Reverse Current at Rated DC Blocking Voltage	T _A =25°C	I _R	30	μA
	T _A =125°C		1000	
Typical Junction Capacitance	4.0 V, 1 MHz	C _J	96	pF

Thermal Characteristics

Parameter	Symbol	Value	Unit
Typical Thermal Resistance ⁽¹⁾	R _{θJA}	65	°C/W
	R _{θJC}	25	
	R _{θJL}	15	

Note1: Thermal resistance from junction to lead, mounted on PCB with 8.0×8.0mm copper pads.

Ratings and Characteristics Curves

($T_A = 25^\circ\text{C}$ unless otherwise noted)

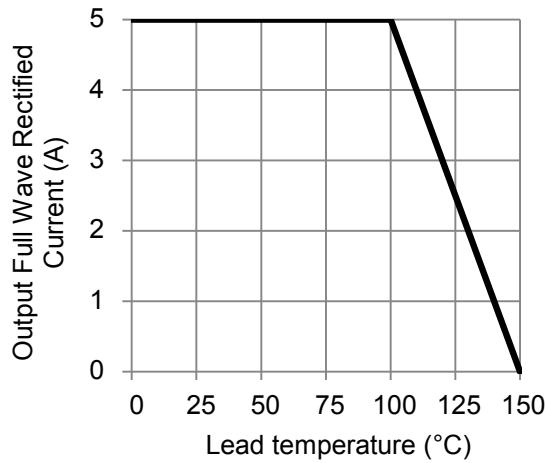

Figure 1. Forward Current Derating Curve

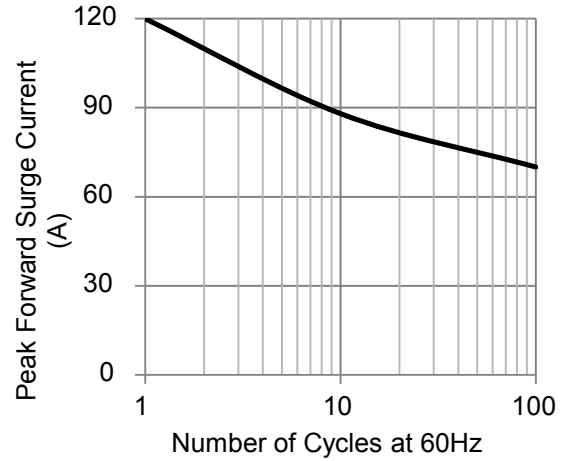

Figure 2. Maximum Non-Repetitive Peak Forward Surge Current

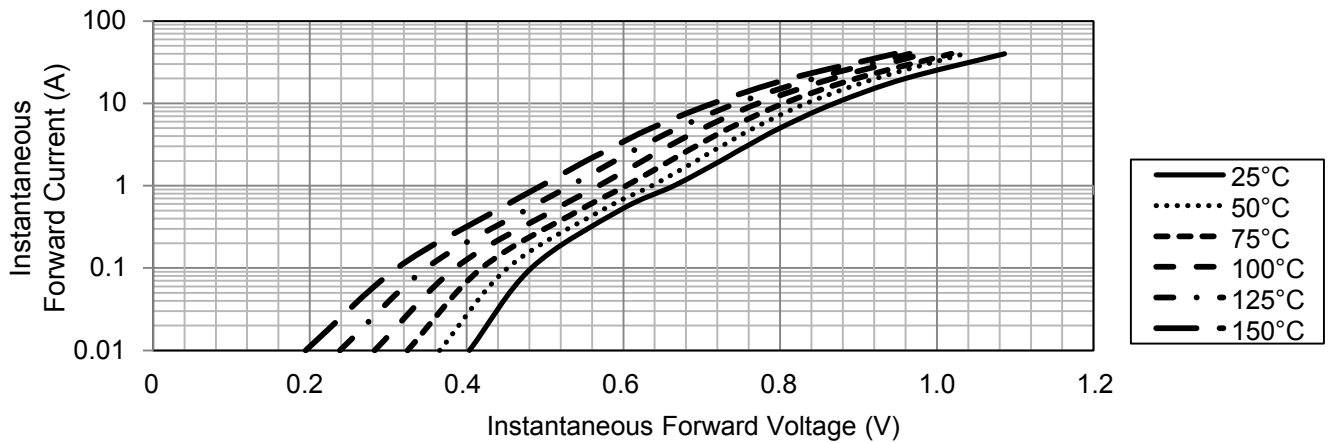

Figure 3. Typical Instantaneous Forward Characteristics

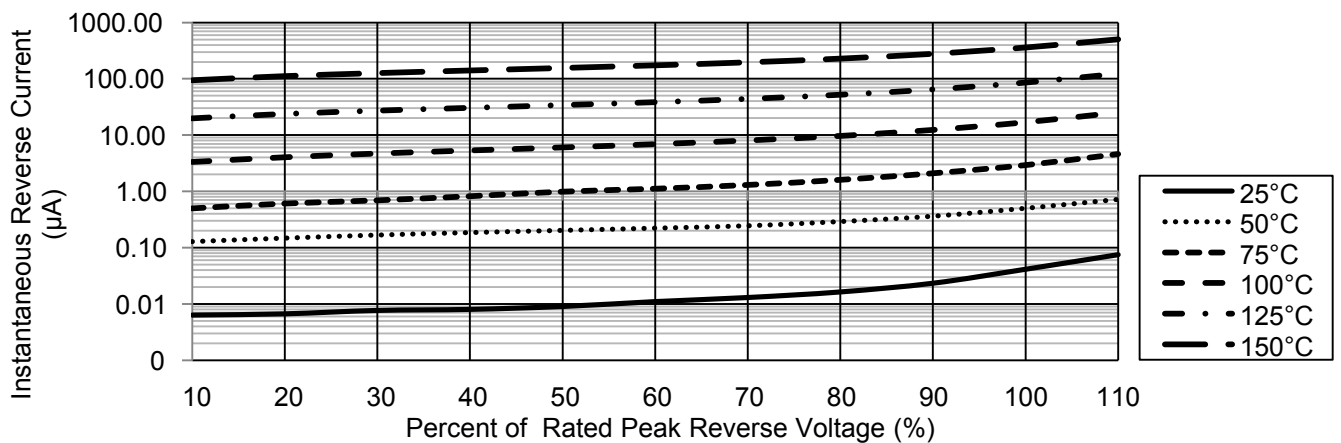
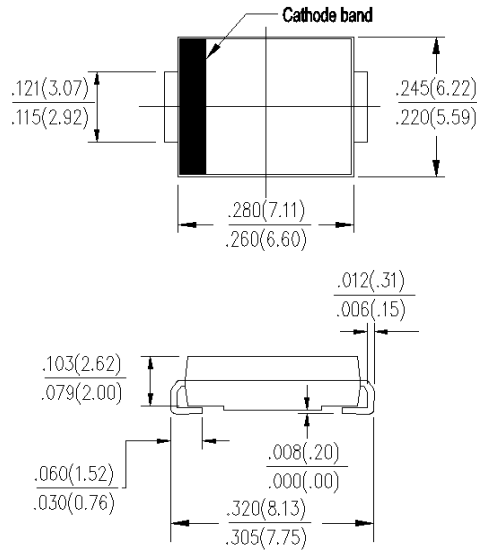

Figure 4. Typical Reverse Characteristics

Package Outline Dimensions

in inches (millimeters)

DO-214AB (SMC)



Mounting Pad Layout

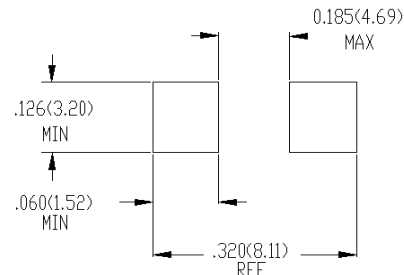

Packing Information

3000 pcs/Reel, 14 Reels/Box; 16mm Tape, 13" Reel

Tape & Reel Specification

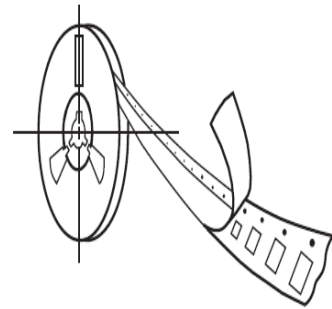
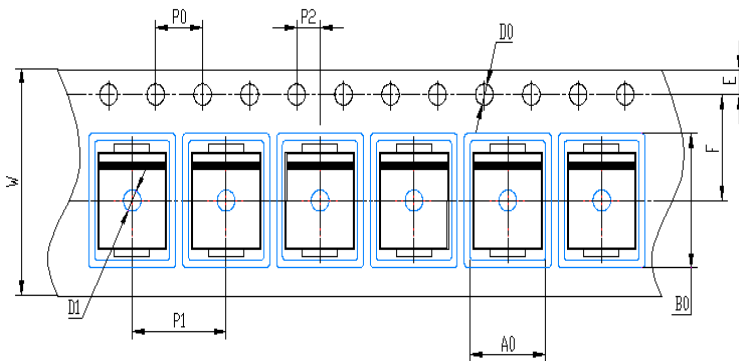

Symbol	SMC(mm)
W	16±0.2
E	1.75±0.1
F	7.5±0.05
D0	1.5±0.1
D1	1.50 +0.1/-0
P0	4.0±0.1
P1	8.0±0.1
P2	2.0±0.05
A0	6.22±0.1
B0	8.31±0.1

Soldering Parameters

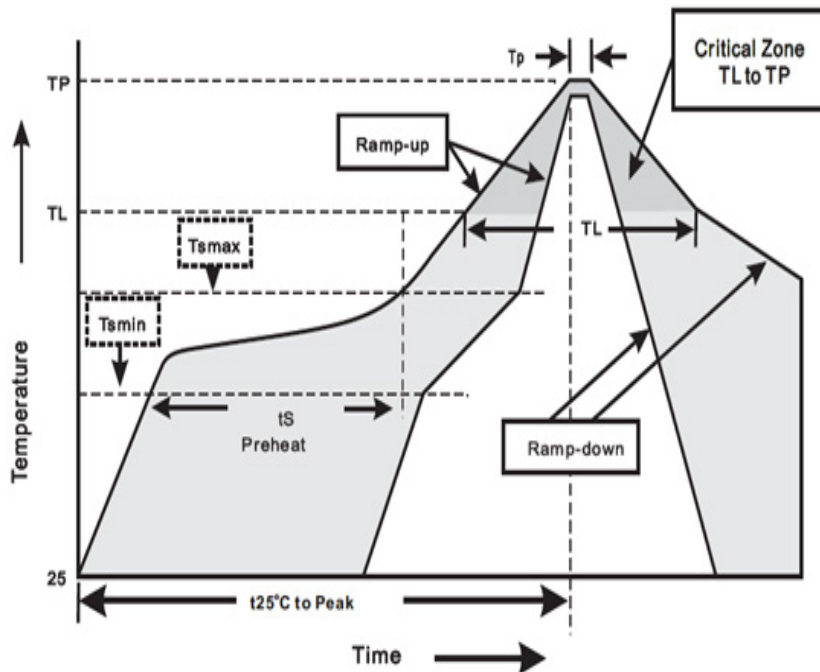

Reflow Soldering		Sn-Pb Eutectic Assembly	Pb-Free Assembly
Pre Heat	- Temperature Min (Ts min)	100°C	150°C
	- Temperature Max (Ts max)	150°C	200°C
	- Time (min to max) (ts)	60 – 120 secs	60 – 180 secs
Average ramp up rate (Liquidus) Temp (TL) to peak		3°C/second max	3°C/second max
TS(max) to TL - Ramp-up Rate		3°C/second max	3°C/second max
Reflow	- Temperature (TL) (Liquidus)	183°C	217°C
	- Time (min to max) (ts)	60 – 150 seconds	60 – 150 seconds
Peak Temperature (TP)		240+0/-5 °C	240+0/-5°C
Time within 5°C of actual peak Temperature (tp)		10 –30 seconds	20 – 40 seconds
Ramp-down Rate		6°C/second max	6°C/second max
Time 25°C to peak Temperature (TP)		6 minutes max	8 minutes max
Do not exceed		260°C	260°C

Wave Soldering	
Peak Temperature	260+0/-5°C
Dipping Time	10 seconds
Soldering	1 time