

# MUR1060CT/MUR1060FCT

Ultrafast Recovery Rectifiers  
Reverse Voltage 600V Forward Current 10 A

## Features

- FRED (Planar) wafer construction
- Ultrafast recovery time
- Low forward voltage drop, low power loss
- High efficiency
- Plastic package has underwriters Laboratory Flammability Classification 94V-0

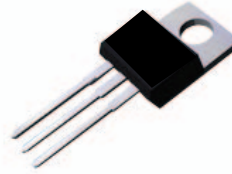

**MUR1060CT**  
Package: TO-220-AB

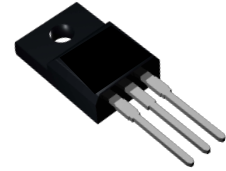

**MUR1060FCT**  
Package: ITO-220-AB

## Mechanical Data

- Case: Epoxy, molded
- Weight: 1.9grams (approximately)
- Finish: all external surfaces corrosion resistant and terminal leads readily solderable
- Lead temperature for soldering purposes: 260°C Max. for 10 sec
- 50 units per plastic tube

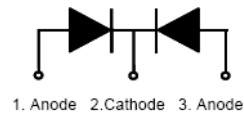

**Schematic Diagram**

## Maximum Ratings & Electrical Characteristics

( $T_A=25^\circ\text{C}$  unless otherwise noted)

Parameter	Test Conditions		Symbol	Value	Unit
Maximum Repetitive Peak Reverse Voltage			$V_{RRM}$	600	V
Working Peak Reverse Voltage			$V_{RWM}$	600	V
Maximum DC Blocking Voltage			$V_{DC}$	600	V
Maximum Average Forward Rectified Current @ $T_c=105^\circ\text{C}$	Total Device		$I_F(AV)$	10	A
	Per Diode			5	
Peak Forward Surge Current 8.3ms Single Half Sine-wave Superimposed on Rated Load per Diode			$I_{FSM}$	90	A
Voltage Rate of Change (rated $V_R$ )			$DV/dt$	10000	V/ $\mu\text{s}$
Operating Junction Temperature Range			$T_J$	- 55 to+150	$^\circ\text{C}$
Storage Temperature Range			$T_{STG}$	- 55 to+150	$^\circ\text{C}$
Maximum Reverse Recover Time ( $I_F=0.5A$ , $I_R=1.0A$ , $I_{rec}=0.25A$ )			$T_{rr}$	50	ns
Maximum Instantaneous Forward Voltage per Leg	$I_F=5A$	$T_C=25^\circ\text{C}$	$V_F$	1.60	V
	$I_F=5A$	$T_C=125^\circ\text{C}$		1.50	
Maximum Reverse Current per Leg at Working Peak Reverse Voltage		$T_J=25^\circ\text{C}$	$I_R$	10	$\mu\text{A}$
		$T_J=100^\circ\text{C}$		500	$\mu\text{A}$
<b>Thermal Characteristics <math>T_A=25^\circ\text{C}</math> unless otherwise noted</b>					
Symbol	Parameter		Typ.(MUR1060CT)	Typ.(MUR1060FCT)	Unit
$R_{\theta JC}$	Thermal Resistance, Junction to Case per Leg		2.0	4.0	$^\circ\text{C/W}$
$R_{\theta JA}$	Thermal Resistance, Junction to Ambient per Leg		62.5	62.5	$^\circ\text{C/W}$

**Note:** Pulse test:300us pulse width, duty cycle=2%

## Ratings and Characteristics Curves ( $T_A = 25^\circ\text{C}$ unless otherwise noted)

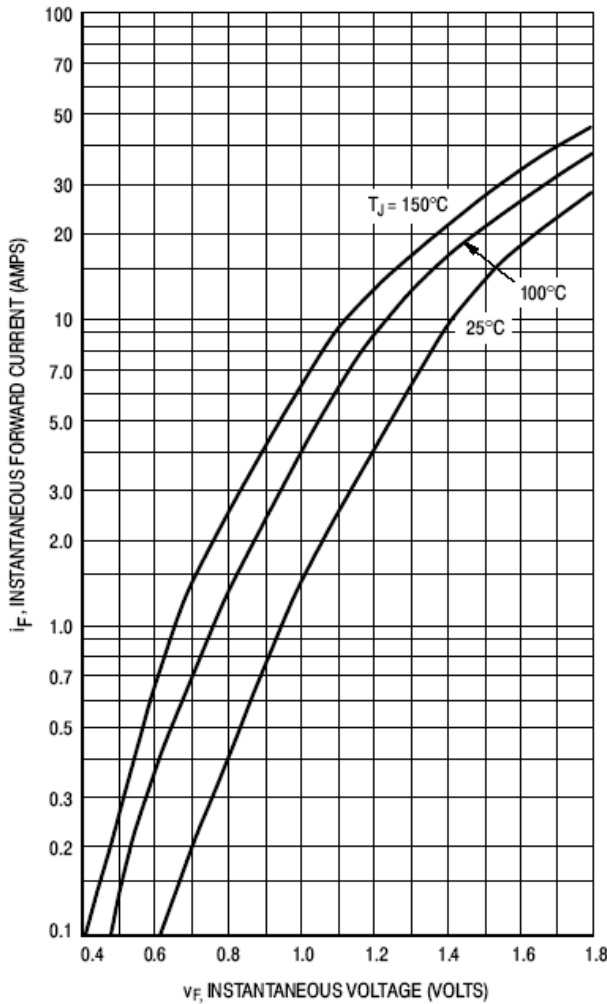

Figure 1. Typical Forward Voltage Per Leg

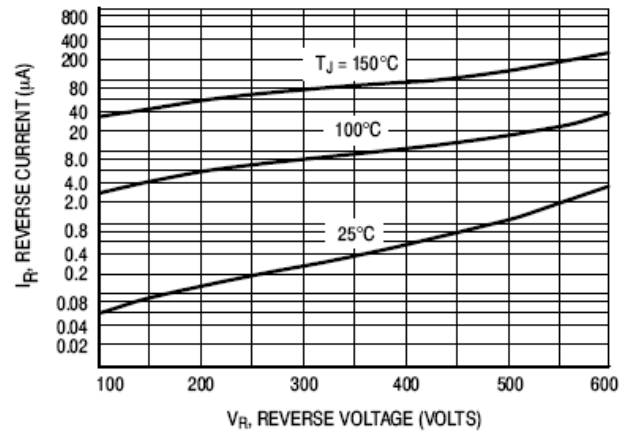

Figure 2. Typical Reverse Current Per Leg

\* The curves shown are typical for the highest voltage device in the voltage grouping. Typical reverse current for lower voltage selections can be estimated from these same curves if  $V_R$  is sufficiently below rated  $V_R$ .

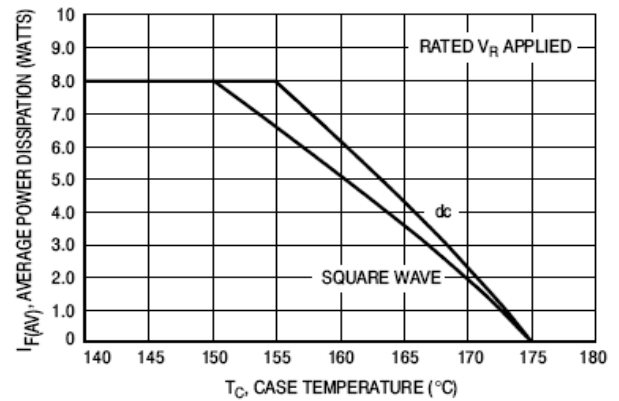

Figure 3. Current Derating, Case, Per Leg

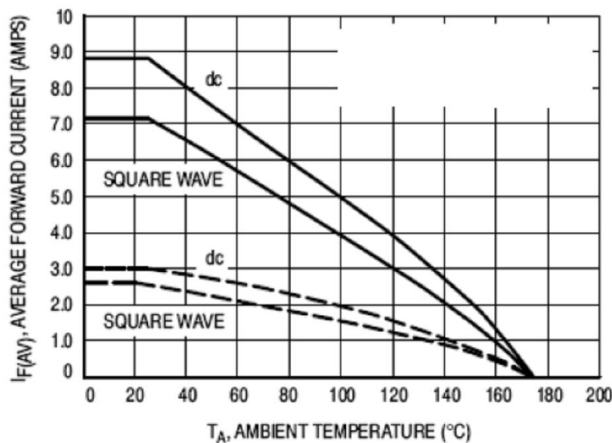

Figure 4. Current Derating, Ambient, Per Leg

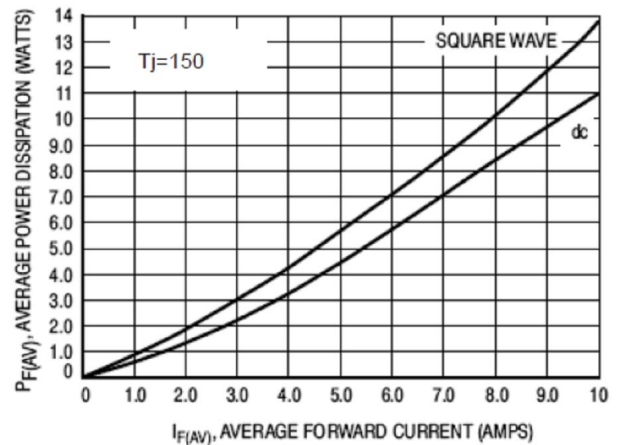

Figure 5. Power Dissipation, Per Leg

# MUR1060CT/MUR1060FCT

Ultrafast Recovery Rectifiers  
Reverse Voltage 600V Forward Current 10 A

## Package Outline Dimensions

in millimeters

TO-220-AB

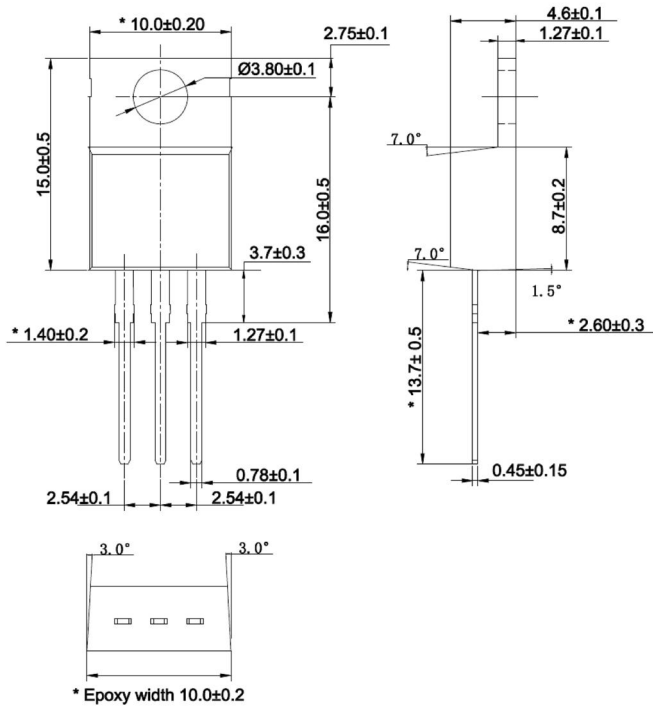

ITO-220-AB

