

Features

- Plastic package has underwriters Laboratory Flammability Classification 94V-0
- Dual rectifier construction, positive center tap
- Low forward voltage, high efficiency
- Guarding for over voltage protection

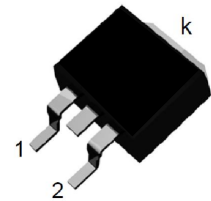

Package: TO-263

Mechanical Data

- Case: epoxy, molded
- Weight: 1.4grams (approximately)
- Lead temperature for soldering purpose: 260°C max. for 10 sec
- 800 pcs/reel

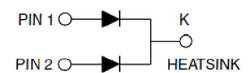

Schematic Diagram

Maximum Ratings & Electrical Characteristics

(T_A=25°C unless otherwise noted)

Parameter	Test Conditions		Symbol	Value	Unit
Maximum Repetitive Peak Reverse Voltage			V _{RRM}	45	V
Working Peak Reverse Voltage			V _{RWM}	45	V
Maximum DC Blocking Voltage			V _{DC}	45	V
Maximum Average Forward Rectified Current @ T _c =105°C	Total Device		I _{F(AV)}	20	A
	Per Diode			10	
Peak Forward Surge Current 8.3ms Single Half Sine-wave Superimposed on Rated Load per Diode			I _{FSM}	150	A
Peak repetitive Reverse Current Per Leg at tp=2.0μs ,1KHz			I _{RRM}	1.0	A
Voltage Rate of Change (rated V _R)			Dv/dt	10000	V/μs
Operating Junction Temperature Range			T _J	- 55 to+150	°C
Storage Temperature Range			T _{STG}	- 55 to+150	°C
Maximum Instantaneous Forward Voltage per Leg	I _F =10A	T _C =25°C	V _F	0.70	V
	I _F =10A	T _C =125°C		0.60	
Maximum Reverse Current per Leg at Working Peak Reverse Voltage	T _J =25°C		I _R	200	μA
	T _J =100°C			15	mA
Thermal Characteristics (T_A=25°C unless otherwise noted)					
Symbol	Parameter	Typ.(TO-263)			Unit
R _{θJC}	Thermal Resistance, Junction to Case per Leg	2.0			°C/W
R _{θJA}	Thermal Resistance, Junction to Ambient per Leg	62.5			°C/W

Note: Pulse test:300us pulse width, duty cycle=2%

Ratings and Characteristics Curves ($T_A = 25^\circ\text{C}$ unless otherwise noted)

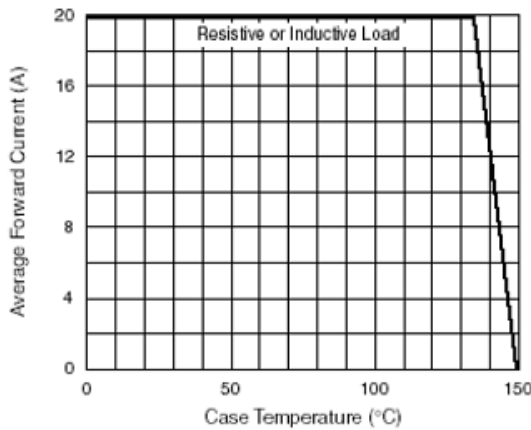

Figure 1. Forward Derating Curve (Total)

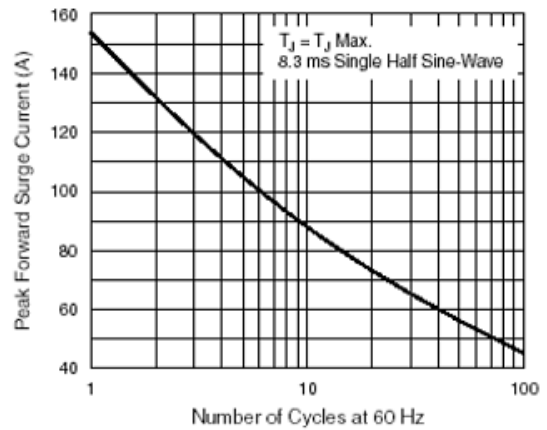

Figure 2. Maximum Non-Repetitive Peak Forward Surge

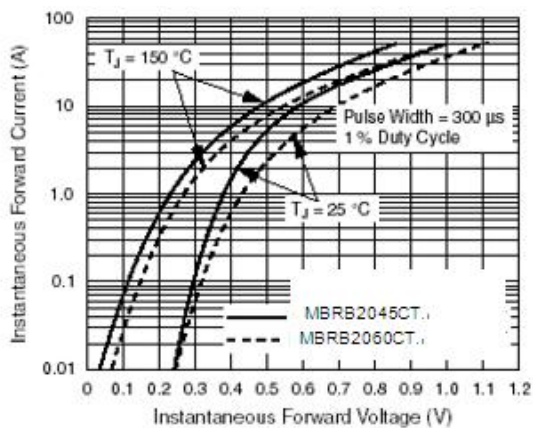

Figure 3. Typical Instantaneous Forward Characteristics Per Diode

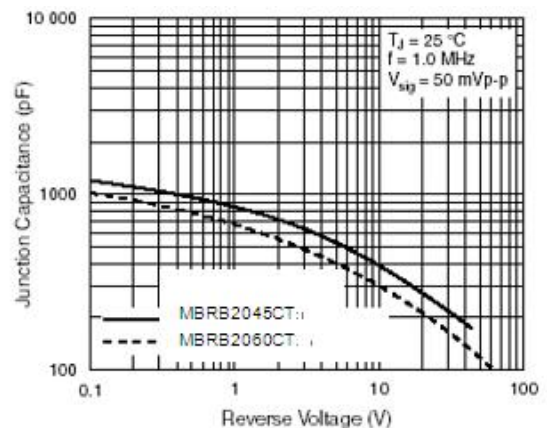

Figure 5. Typical Junction Capacitance Per Diode

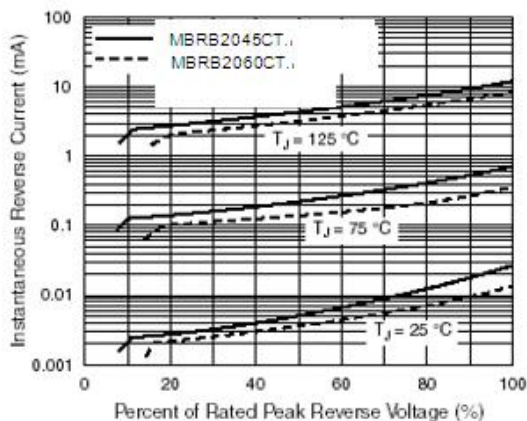

Figure 4. Typical Reverse Characteristics Per Diode

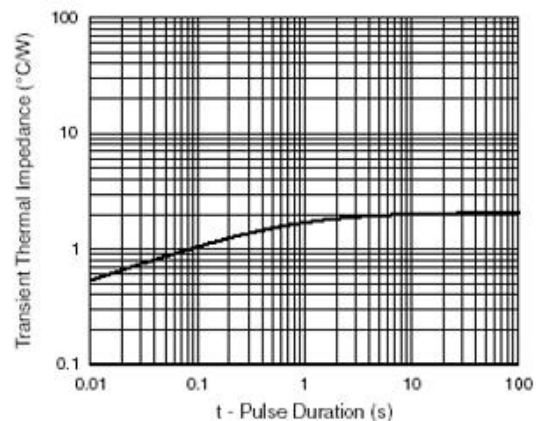
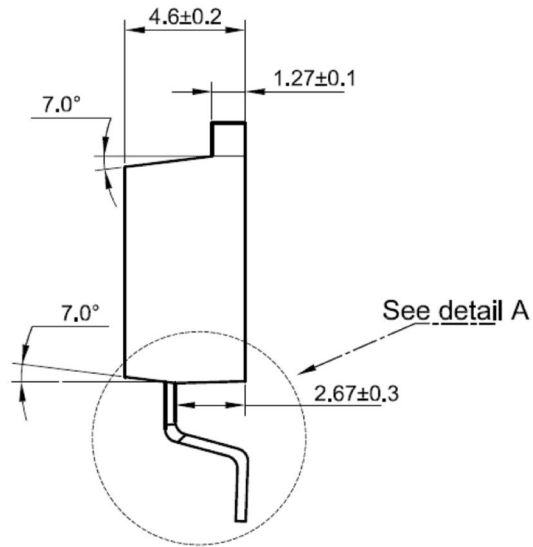
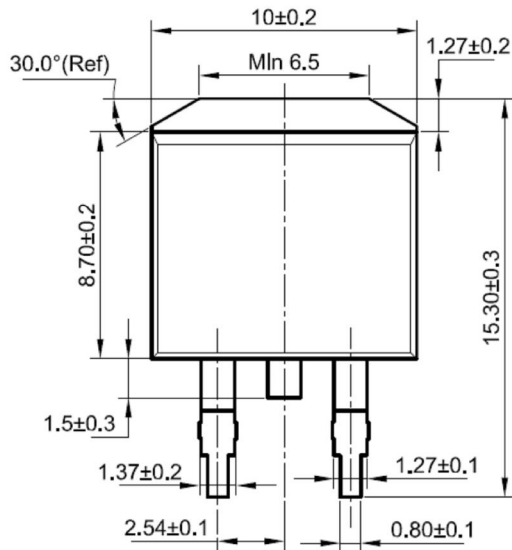

Figure 6. Typical Transient Thermal Impedance Per Diode

Package Outline Dimensions

in millimeters

TO-263



Detail A

