

# MBR30100CT/MBRF30100CT

Schottky Barrier Rectifier  
Reverse Voltage 100 V Forward Current 30 A

## Features

- Plastic package has underwriters Laboratory Flammability Classification 94V-0
- Dual rectifier construction, positive center tap
- Low forward voltage, high efficiency
- Guarding for over voltage protection

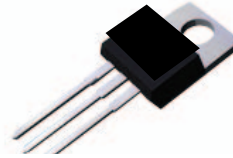

**MBR30100CT**  
Package: TO-220-AB

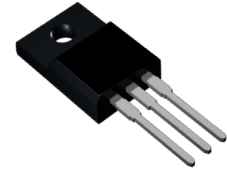

**MBRF30100CT**  
Package: ITO-220-AB

## Mechanical Data

- Case: epoxy, molded
- Weight: 1.9grams (approximately)
- Finish: all external surfaces corrosion resistant and terminal leads readily solderable
- Lead temperature for soldering purpose: 260°C max. for 10 sec
- 50 units per plastic tube

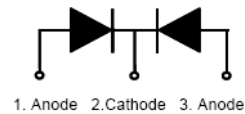

**Schematic Diagram**

## Maximum Ratings & Electrical Characteristics

( $T_A=25^\circ\text{C}$  unless otherwise noted)

Parameter	Test Conditions	Symbol	Value	Unit
Maximum Repetitive Peak Reverse Voltage		$V_{RRM}$	100	V
Working Peak Reverse Voltage		$V_{RWM}$	100	V
Maximum DC Blocking Voltage		$V_{DC}$	100	V
Maximum Average Forward Rectified Current @ $T_c=105^\circ\text{C}$	Total Device Per Diode	$I_{F(AV)}$	30 15	A
Peak Forward Surge Current 8.3ms Single Half Sine-wave Superimposed on Rated Load per Diode		$I_{FSM}$	200	A
Peak repetitive Reverse Current Per Leg at $t_p=2.0\mu\text{s}$ , 1KHz		$I_{RRM}$	1.0	A
Voltage Rate of Change (rated $V_R$ )		$DV/dt$	10000	V/ $\mu\text{s}$
Operating Junction Temperature Range		$T_J$	- 55 to+150	$^\circ\text{C}$
Storage Temperature Range		$T_{STG}$	- 55 to+150	$^\circ\text{C}$
Isolation Voltage (ITO-220-AB only) from Terminal to Heatsink $t = 1 \text{ sec}$		$V_{AC}$	1500	V
Maximum Instantaneous Forward Voltage per Leg	$I_F=15\text{A}$ $T_c=25^\circ\text{C}$ $I_F=15\text{A}$ $T_c=125^\circ\text{C}$	$V_F$	0.85 0.75	V
Maximum Reverse Current per Leg at Working Peak Reverse Voltage	$T_J=25^\circ\text{C}$ $T_J=100^\circ\text{C}$	$I_R$	200 15	$\mu\text{A}$ mA
<b>Thermal Characteristics</b> ( $T_A=25^\circ\text{C}$ unless otherwise noted)				
Symbol	Parameter	Typ.(TO-220-AB)	Typ.(ITO-220-AB)	Unit
$R_{\theta JC}$	Thermal Resistance, Junction to Case per Leg	2.0	4.0	$^\circ\text{C}/\text{W}$
$R_{\theta JA}$	Thermal Resistance, Junction to Ambient per Leg	62.5	62.5	$^\circ\text{C}/\text{W}$

**Note:** Pulse test:300us pulse width, duty cycle=2%

## Ratings and Characteristics Curves ( $T_A = 25^\circ\text{C}$ unless otherwise noted)

FIG. 1- FORWARD CURRENT DERATING CURVE

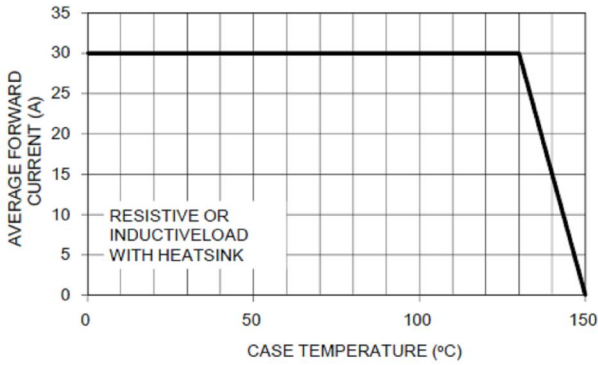

FIG. 2- MAXIMUM NON-REPETITIVE FORWARD SURGE CURRENT PER LEG

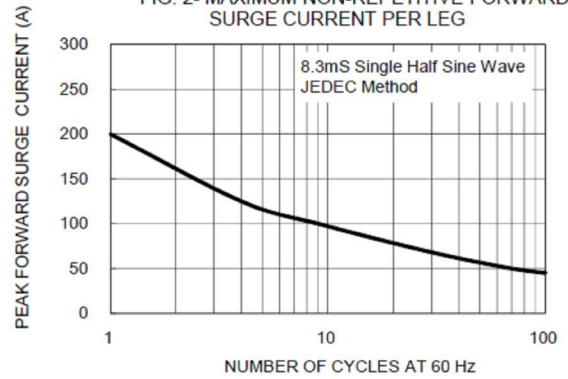

FIG. 3- TYPICAL INSTANTANEOUS FORWARD CHARACTERISTICS PER LEG

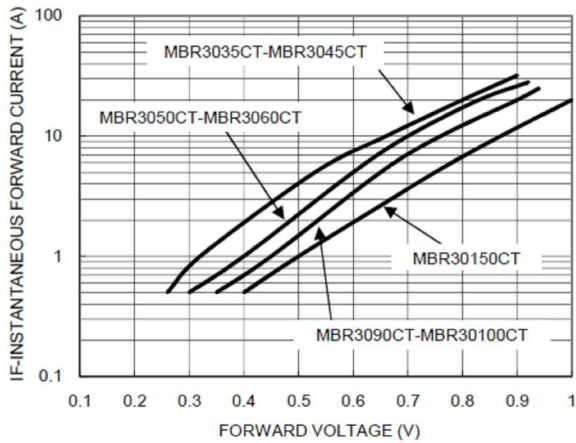

FIG. 4- TYPICAL REVERSE CHARACTERISTICS PER LEG

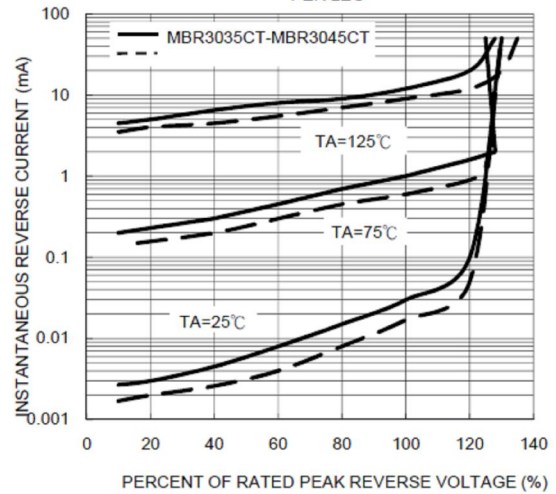

FIG. 5- TYPICAL JUNCTION CAPACITANCE PER LEG

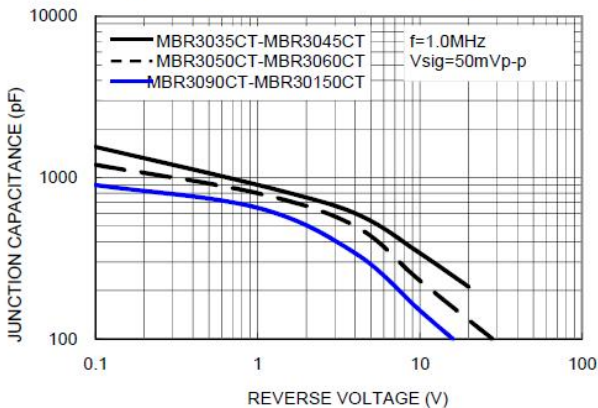
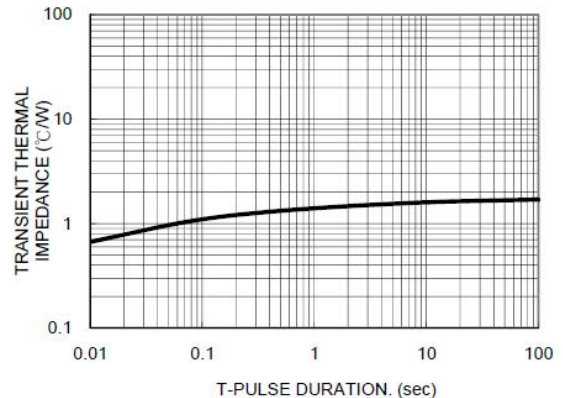

FIG. 6- TYPICAL TRANSIENT THERMAL IMPEDANCE PER LEG



## Package Outline Dimensions

in millimeters

TO-220-AB

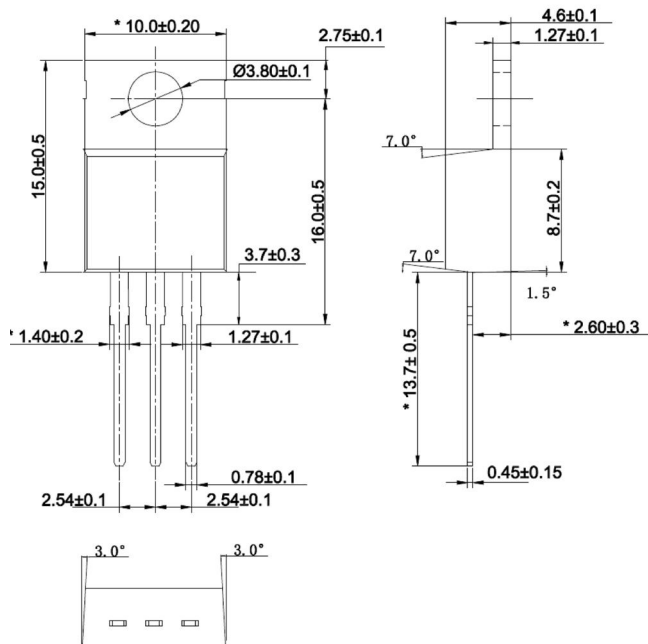

ITO-220-AB

