

## Features

- Glass passivated junction chip
- For surface mount applications
- Low forward voltage drop
- Low profile package
- Built-in stain relief, ideal for automated placement
- Fast switching for high efficiency
- Plastic package has Underwriters Laboratory Flammability Classification 94V-0
- Weight: 0.003 ounce, 0.093gram

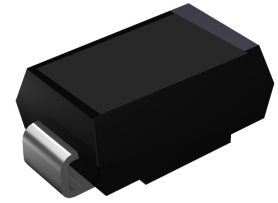

Package: DO-214AA (SMB)



## Applications

For use of general purpose rectifications in lighting, cellular phones, portable devices, power supplies and other consumer applications.

## Maximum Ratings (T<sub>A</sub> = 25°C unless otherwise noted)

Parameter	Symbol	HS3AB	HS3BB	HS3DB	HS3FB	HS3GB	HS3JB	HS3KB	HS3MB	Unit
Maximum Repetitive Peak Reverse Voltage	V <sub>RRM</sub>	50	100	200	300	400	600	800	1000	V
Maximum RMS Voltage	V <sub>RMS</sub>	35	70	140	210	280	420	560	700	V
Maximum DC Blocking Voltage	V <sub>DC</sub>	50	100	200	300	400	600	800	1000	V
Maximum Average Output Rectified Current	I <sub>F(AV)</sub>	3.0								A
Peak Forward Surge Current (8.3 ms single half sine-wave superimposed on rated load)	I <sub>FSM</sub>	150								A
Operating Junction and Storage Temperature Range	T <sub>J</sub> , T <sub>STG</sub>	-55 to +150								°C

## Electrical Characteristics (T<sub>A</sub> = 25°C unless otherwise noted)

Parameter	Test Conditions	Symbol	HS3AB	HS3BB	HS3DB	HS3FB	HS3GB	HS3JB	HS3KB	HS3MB	Unit
Maximum Instantaneous Forward Voltage	I <sub>F</sub> =3A	V <sub>F</sub>	1.0			1.3		1.7			V
Maximum DC Reverse Current at Rated DC Blocking Voltage	T <sub>A</sub> =25°C T <sub>A</sub> =100°C	I <sub>R</sub>	10				200				μA
Maximum Reverse Recovery Time	I <sub>F</sub> =0.5A, I <sub>R</sub> =1.0A, I <sub>RR</sub> =0.25A	t <sub>rr</sub>	50				75				ns
Typical Junction Capacitance	4.0 V, 1 MHz	C <sub>J</sub>	80				50				pF

## Ratings and Characteristics Curves ( $T_A = 25^\circ\text{C}$ unless otherwise noted)

FIG.1- REVERSE RECOVERY TIME CHARACTERISTIC AND TEST CIRCUIT DIAGRAM      FIG.2- MAXIMUM FORWARD CURRENT DERATING CURVE

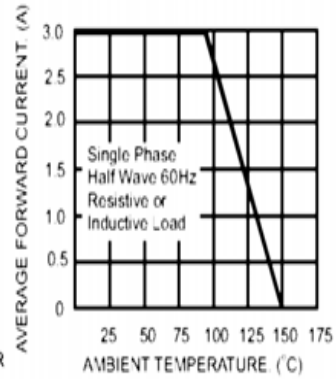
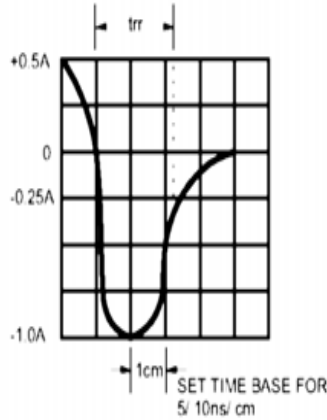
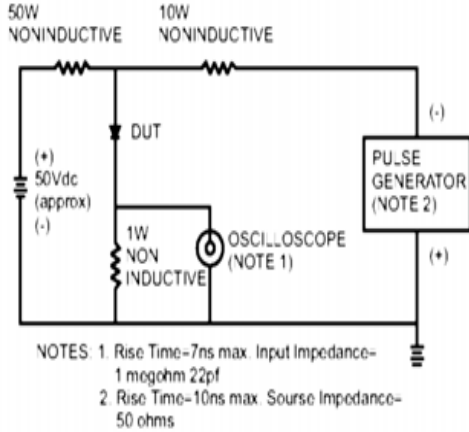

FIG.3- TYPICAL REVERSE CHARACTERISTICS

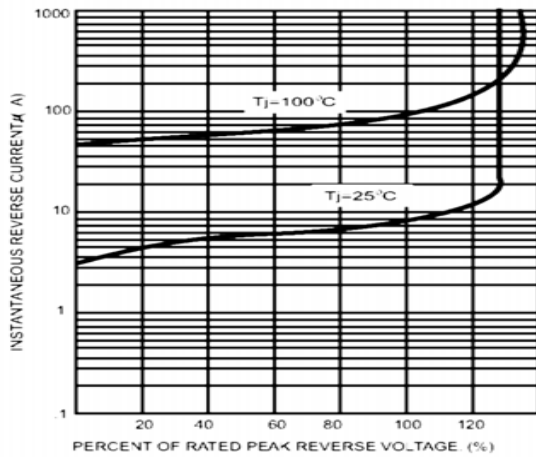

FIG.4- TYPICAL INSTANTANEOUS FORWARD CHARACTERISTICS

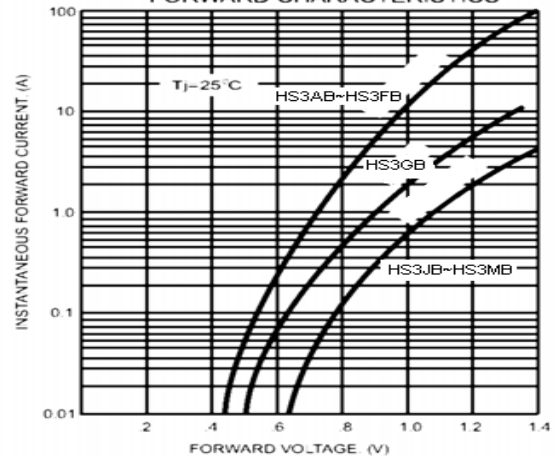

FIG.5- MAXIMUM NON-REPETITIVE FORWARD SURGE CURRENT

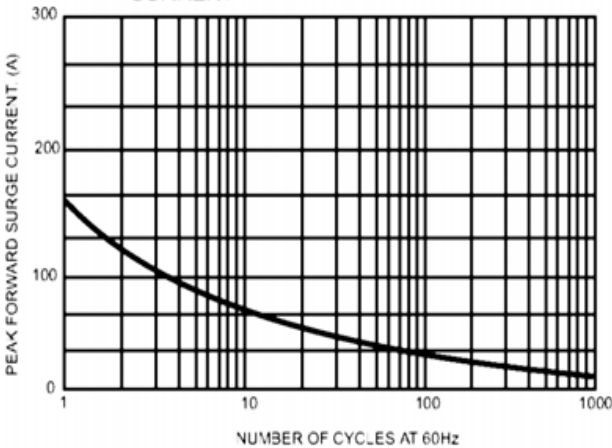
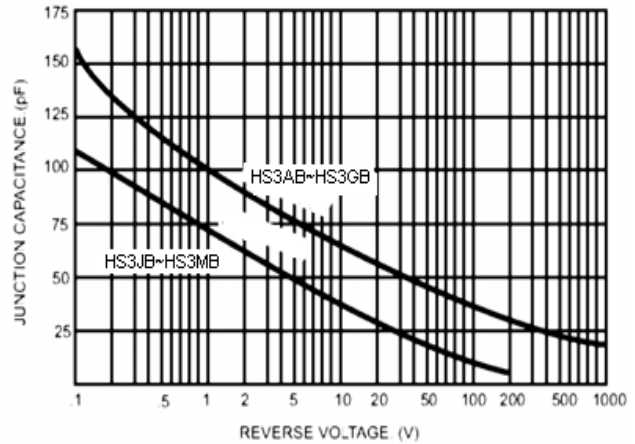

FIG.6- TYPICAL JUNCTION CAPACITANCE



## Package Outline Dimensions

in inches (millimeters)

Package: SMB (DO-214AA)

