

SPP08065D1

650V Silicon Carbide Diode

Features

- 650-Volt Schottky Rectifier
- Shorter recovery time
- High-speed switching possible
- High-Frequency Operation
- Temperature-Independent Switching Behavior
- Extremely Fast Switching
- Positive Temperature Coefficient on VF

Benefits

- Higher safety margin against overvoltage
- Improved efficiency all load conditions
- Increased efficiency compared to Silicon Diode alternatives
- Reduction of Heat Sink Requirements
- Parallel Devices Without Thermal Runaway
- Essentially No Switching Losses

Applications

- Switch Mode Power Supplies
- Power Factor Correction
- Motor Drives
- HID Lighting

Package



Type : TO-220 -2lead

1, Cathode 2, Anode

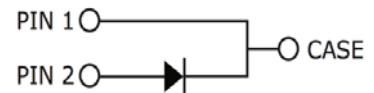

Absolute Maximum Ratings $T_c = 25^\circ\text{C}$ unless otherwise noted

Symbol	Parameter	SPP08065D1	Units
VRRM	Repetitive Peak Reverse Voltage	650	V
VRSM	Surge Peak Reverse Voltage	650	V
VDC	DC Blocking Voltage	650	V
IF	Continuous Forward Current @Tc=25°C @Tc=135°C @Tc=150°C	24 11 8	A
IFRM	Repetitive Peak Forward Surge Current tp = 10 ms, Half Sine Wave @TC=25°C @TC=110°C	56 35	A
IFSM	Non-Repetitive Peak Forward Surge Current tp= 10 ms, Half Sine Wave @TC=25°C @TC=110°C	78 57	A
IFSM	Non-Repetitive Peak Forward Surge Current @TC=25°C, tp= 10 us, pulse	200	A
Ptot	Power Dissipation @Tc=25°C @Tc=110°C	117 51	W
TJ , Tstg	Operating Junction and Storage Temperature	-55 to +175	°C

Electrical Characteristics

$T_C = 25^\circ \text{C}$ unless otherwise noted

Symbol	Test Conditions	Test Conditions	Min	Typ	Max	Unit
VF	Forward Voltage	IF=8A, TC=25° C IF=8A, TC=175° C	-	1.5 2.0	1.8 2.5	V
IR	Reverse Current	VR=650V, TC=25° C VR=650V, TC=175° C	-	10 20	50 100	μA
QC	Total Capacitive Charge	VR =400V, IF =8A TJ = 25° C $Qc = \int_0^{Vr} C (V) dv$	-	26	-	nC
C	Total Capacitance	VR =0V, TJ = 25° C, f=1MHz VR =200V, TJ = 25° C, f=1MHz VR =400V, TJ = 25° C, f=1MHz	-	379 40 32	-	pF
EC	Capacitance Stored Energy	VR=400V	-	4.9	-	μJ

Thermal Characteristics

Symbol	Parameter	Typ	Unit
RθJC	Thermal Resistance from Junction to Case	1.28	°C/W

Typical Characteristics

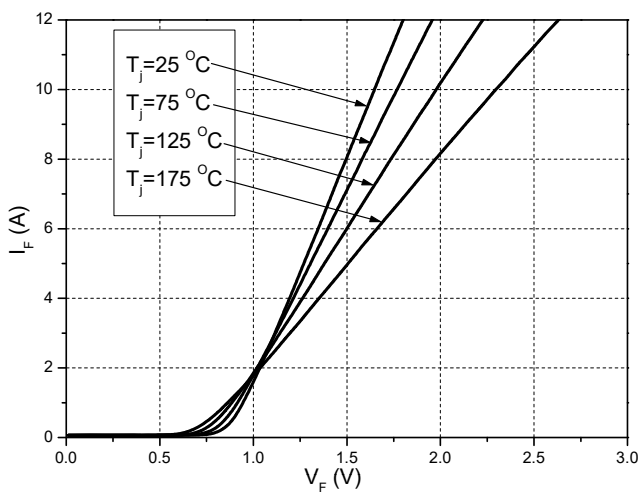

Figure 1. Forward Characteristics

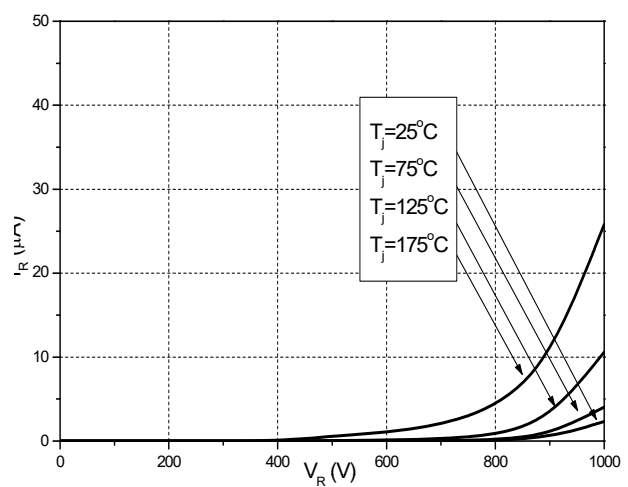

Figure 2. Reverse Characteristics

Typical Characteristics

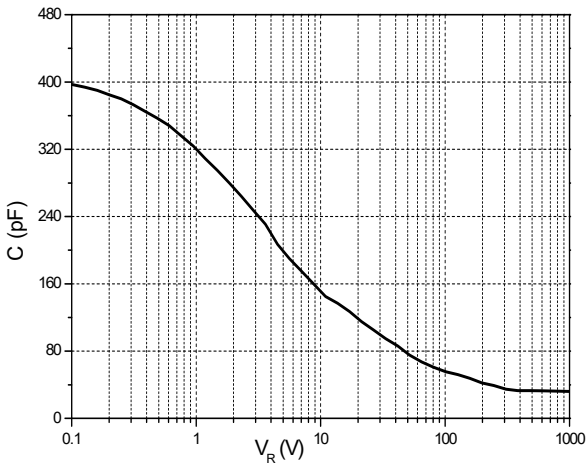

Figure 3. Capacitance vs. Reverse Voltage

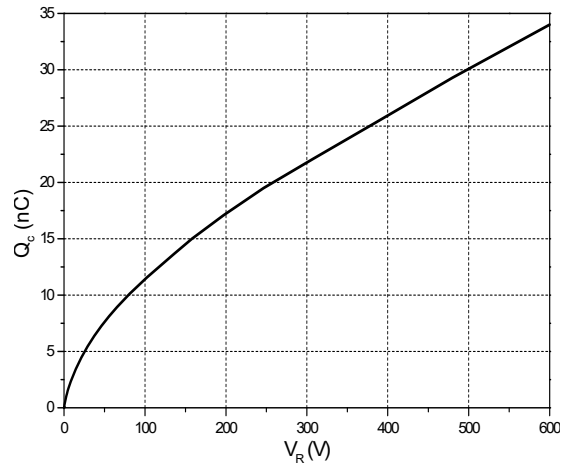

Figure 4. Total Capacitance Charge vs. Reverse Voltage

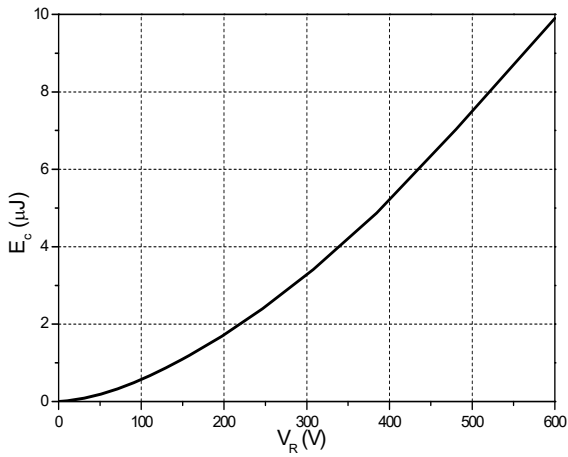

Figure 5. Capacitance Stored Energy

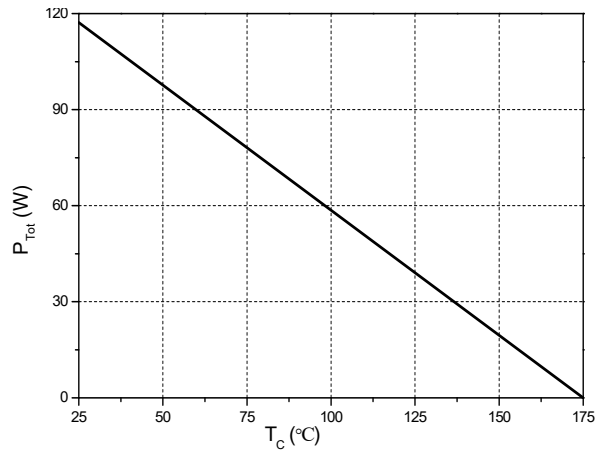

Figure 6. Power Derating

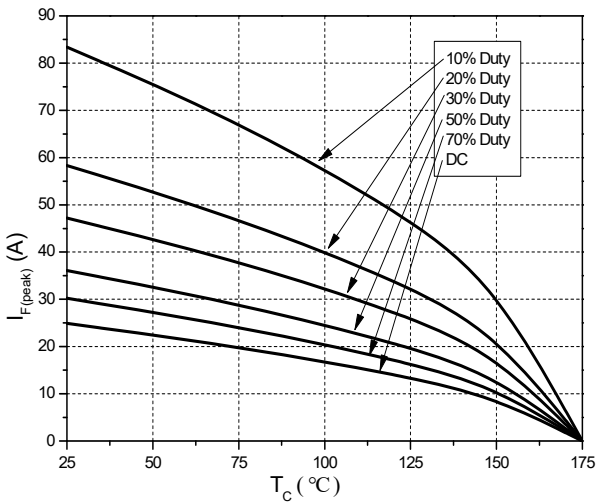

Figure 7. Current Derating

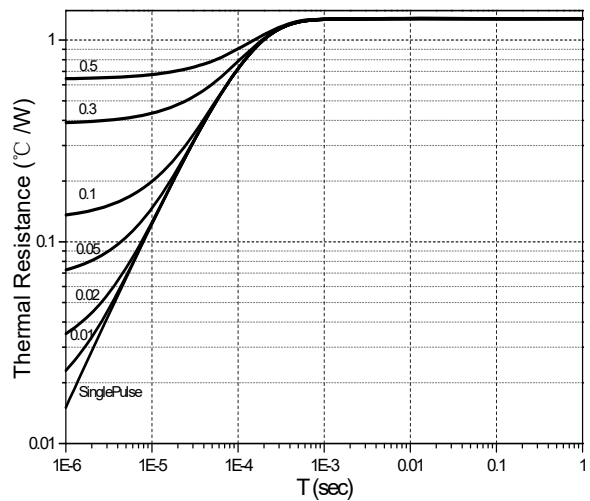
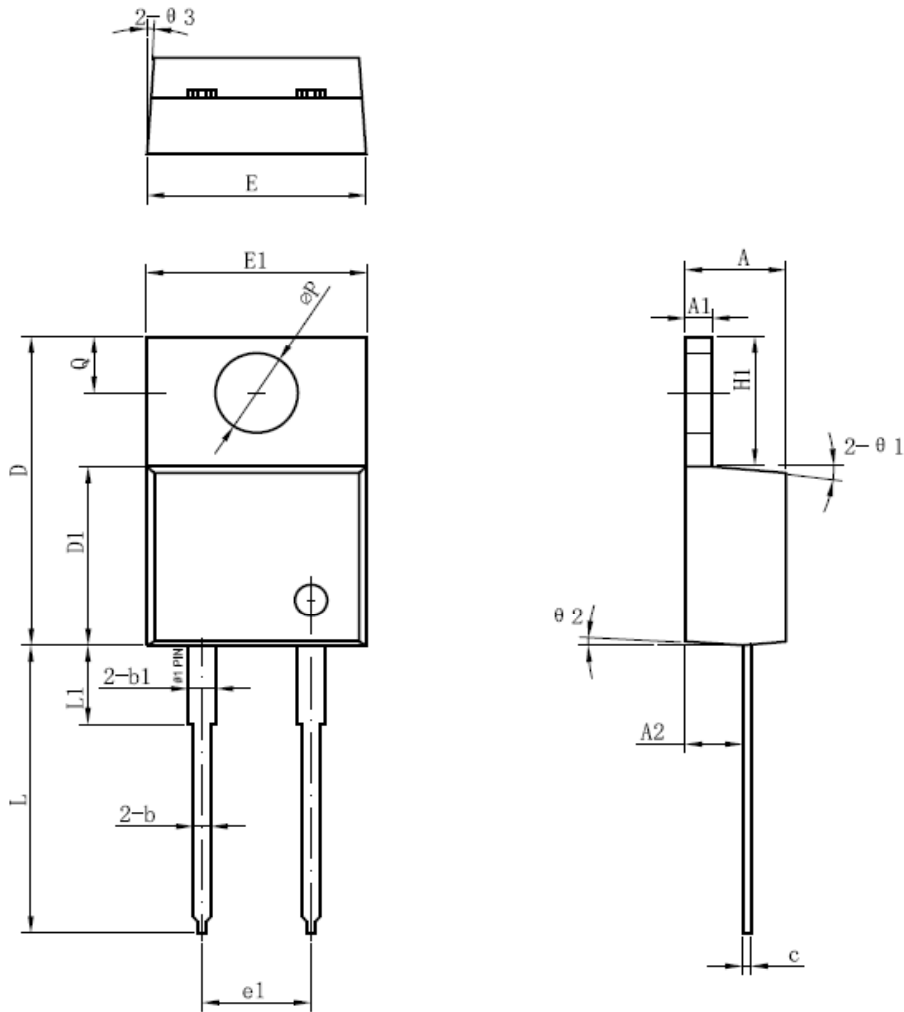

Figure 8. Transient Thermal Impedance

Package Dimensions TO-220-2Lead



Symbol	Millimeters		
	Min.	Typ.	Max.
A	4.55	4.70	4.85
A1	1.17	1.27	1.37
A2	2.59	2.69	2.89
b	0.71	0.81	0.96
b1		1.27	
c	0.36	0.38	0.61
D	14.64	14.94	15.24
D1	8.55	8.70	8.85
E	10.01	10.16	10.31
E1	9.98	10.18	10.38
e1		5.08	
H1	6.04	6.24	6.44
L	13.00	13.86	14.08
L1		3.80	
φP	3.74	3.84	4.04
Q	2.54	2.74	2.94
θ1		5°	
θ2		4°	
θ3		4°	

Marking Layout



1ST Line : Company logo

2nd Line : Date code

3rd Line : Device name