

Features

- DFN2010 package
- Protects up to 4-Lines operating at 5V
- R2R + Zener technology
- Low clamping voltage
- Low leakage current
- Ultra low capacitance (0.15pF typical I/O to I/O)
- ESD Protection for high-speed data lines to:
IEC 61000-4-2 ±8KV contact ±15KV air
- RoHS compliant

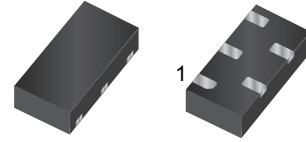

DFN2010

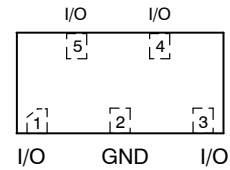

Pin Configuration

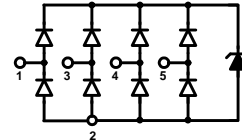

Schematic Diagram

Applications

- USB 3.0/3.1
- HDMI 1.4/2.0, Display Port 1.3, eSATA
- Unified Display Interface (UDI)
- Digital Visual Interface (DVI)
- High speed serial interfaces

Absolute Maximum Ratings (T_A=25°C unless otherwise specified)

Parameter	Symbol	Value	Unit
Junction Temperature	T _J	-55 to +125	°C
Storage Temperature	T _{STG}	-55 to +150	°C
Lead Soldering Temperature	T _L	260 (10sec.)	°C
Peak Pulse Current (t _P = 8/20µS)	I _{PP}	3	A
IEC 61000-4-2 Contact (ESD)	VESD	±8	kV
IEC 61000-4-2 Air (ESD)	VESD	±15	kV

Electrical Characteristics (T_A=25°C unless otherwise specified)

Parameter	Symbol	Condition	Min	Typ	Max	Unit
Reverse Stand-off Voltage	V _{RWM}	-	-	-	5	V
Reverse Breakdown Voltage	V _{BR}	I _T =1mA	6	7.2	9.5	V
Reverse Leakage Current	I _R	V _R =5V	-	0.01	1	µA
Clamping Voltage (IEC 61000-4-5)	V _C	I _{PP} =3A, T _P =8/20µS	-	10	-	V
Trigger Voltage (IEC 61000-4-2)	V _T	V _{ESD} =8kV	-	135	-	V
Clamping Voltage (IEC 61000-4-2)	V _C	V _{ESD} =8kV	-	20	-	V
Junction Capacitance	C _J	V _R =0V, f=1MHz, I/O to I/O	-	0.15	-	pF
	C _J	V _R =0V, f=1MHz, I/O to GND	-	0.35	-	pF

Typical Characteristic Curves

Fig.1 Pulse Waveform-ESD(IEC61000-4-2)

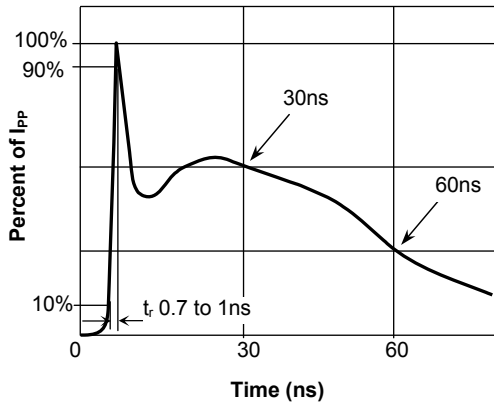

Fig.2 IEC61000-4-2 +8kV Contact ESD Clamping Waveform

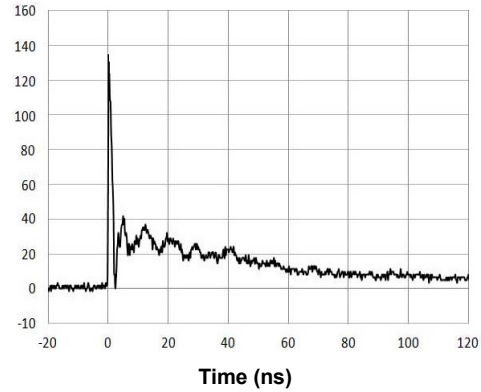

Fig.3 Eye Diagram - USB3.1 at 10Gbps per channel (with SPESUC5VD2010-5U)

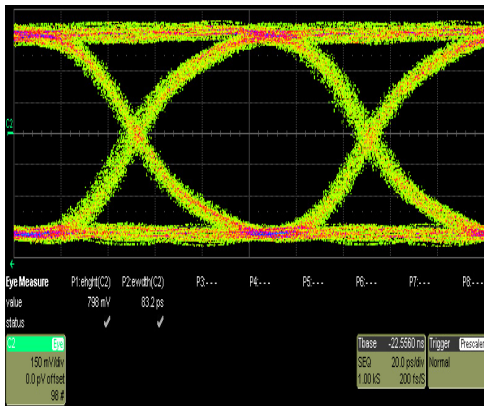
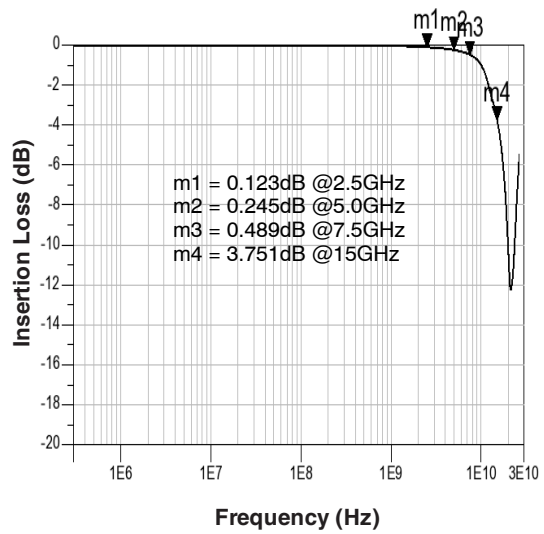
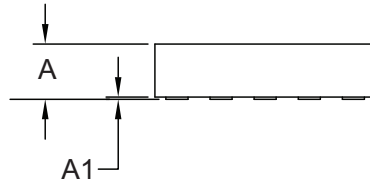
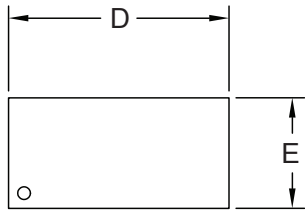

Fig.4 Insertion Loss S21 - I/O to I/O



Product Dimensions

DFN2010



Dim	Millimeters		
	Min	Nom	Max
A	0.45	0.50	0.55
A1	0.00	0.02	0.05
b	0.15	0.20	0.25
D	1.95	2.00	2.05
E	0.95	1.00	1.05
e	0.40 BSC		
e1	0.80 BSC		
L	0.25	0.30	0.35
N	5		

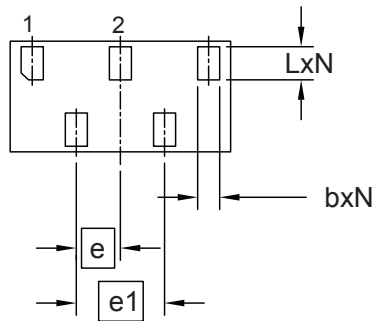

Marking

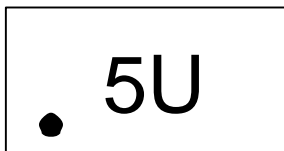

Order Information

Device	Package	Carrier	Quantity	HSF Status
SPESUC5VD2010-5U	DFN2010	Tape & Reel (7")	3000pcs / Reel	RoHS Compliant