

Features

- 200 Watts peak pulse power ($t_p = 8/20\mu s$)
- SOT-23 package
- Protects one bidirectional or two unidirectional lines
- Fast response time, typically < 1 ns
- Excellent clamping voltage
- Low leakage current
- IEC 61000-4-2 ± 15 kV (Air) ESD protection
- IEC 61000-4-2 ± 8 kV (Contact) ESD protection
- IEC 61000-4-5 16A (8/20 μs) Lightning protection
- RoHS compliant

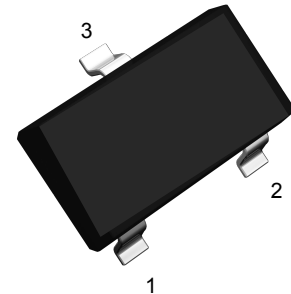

Package: SOT-23

Applications

- Cellular Handsets and Accessories
- Portable Electronics
- Control & Monitoring Systems
- Servers, Notebooks, and Desktop Pcs
- Set-Top Box
- Communication Systems

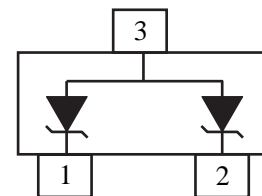

Schematic Diagram

Absolute Maximum Ratings

($T_A = 25^\circ C$ unless otherwise specified)

Rating	Symbols	Value	Units
Peak Pulse Power ($t_p = 8/20\mu s$)	P_{PP}	200	W
Peak Pulse Current ($t_p = 8/20\mu s$)	I_{PP}	16	A
Operating Temperature	T_J	-55 to +150	$^\circ C$
Storage temperature	T_{STG}	-50 to +150	$^\circ C$

Electrical Characteristics

($T_A = 25^\circ C$ unless otherwise specified)

Parameter	Symbols	Conditions	Min	Typ	Max	Units
Reverse stand-off Voltage	V_{RWM}	-	-	-	3.3	V
Reverse Breakdown Voltage	V_{BR}	$I_T = 1mA$	5	-	5.9	V
Reverse Leakage Current	I_R	$V_{RWM} = 3.3V$	-	-	10	μA
Clamping Voltage	V_C	$I_{PP} = 16A, T_p = 8/20\mu s$	-	-	13	V
Junction Capacitance	C_J	$V_R = 0V, f = 1MHz$	-	120		pF

Typical Characteristic Curves

Fig.1 Peak Pulse Power vs Pulse Time

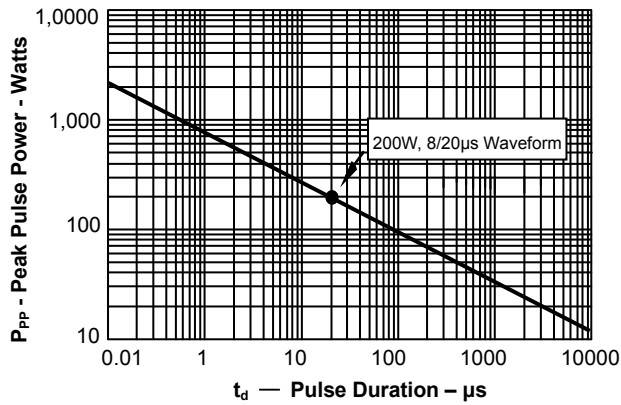

Fig.2 Pulse WaveForm-8/20 μs

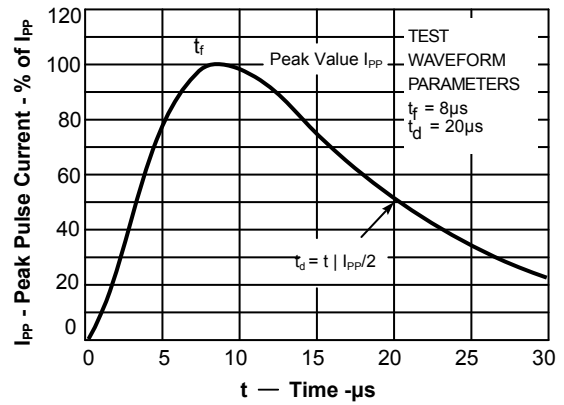

Fig.3 Power Derating Curve

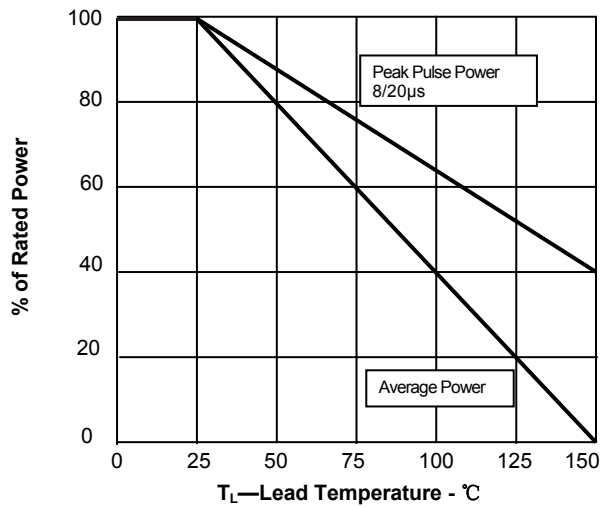
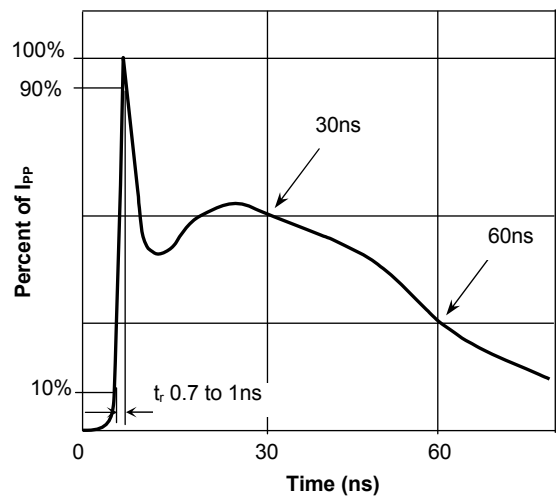
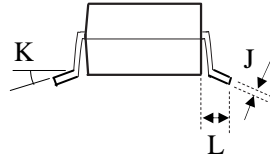
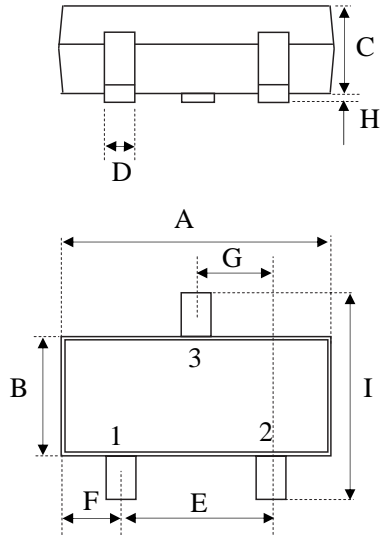

Fig.4 Pulse Waveform-ESD(IEC61000-4-2)



Product Dimensions



Dim	millimeters	
	min	max
A	2.80	3.04
B	1.20	1.40
C	0.89	1.11
D	0.37	0.50
E	1.78	2.04
F	0.45	0.60
G	0.89	1.02
H	0.013	0.100
I	2.10	2.50
J	0.085	0.177
K	0°	10°
L	0.45	0.60

Package Information

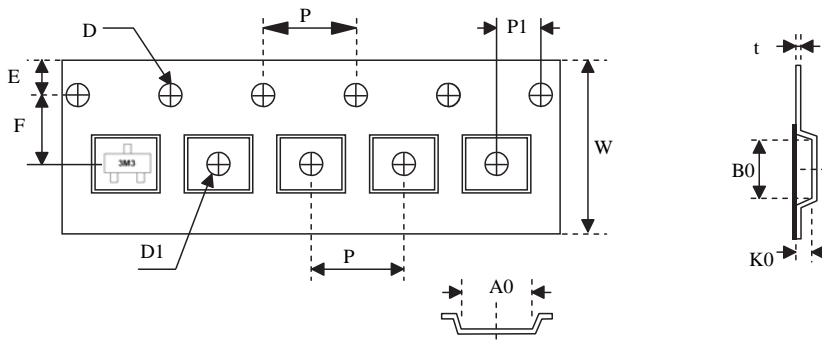

Unit:mm

A0	B0	K0	D1	D	E	F	W	P	P1	t
3.15±0.10	2.77±0.10	1.22±0.10	0.95~1.10	1.50~1.60	1.75±0.10	3.50±0.05	7.90~8.3	4.00±0.10	2.00±0.05	0.22±0.40

Marking

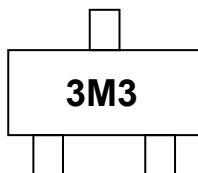

Order Information

Device	Package	Net Weight	Carrier	Quantity	HSF Status
SPESP3V3T23-3	SOT-23	0.0090g	Tape & Reel	3000pcs	RoHS compliant