

Features

- ✧ Darlingon Amplifier



1. BASE
2. EMITTER
3. COLLECTOR

Marking : MMBTA13:K2D; MMBTA14:K3D

SOT-23

MAXIMUM RATINGS (T_A=25°C unless otherwise noted)

Symbol	Parameter	Value	Units
V _{CB0}	Collector-Base Voltage	30	V
V _{CEO}	Collector-Emitter Voltage	30	V
V _{EBO}	Emitter-Base Voltage	10	V
I _C	Collector Current -Continuous	0.3	A
P _C	Collector Power Dissipation	350	mW
R _{θJA}	Thermal Resistance Junction to Ambient	417	°C/W
T _J	Junction Temperature	150	°C
T _{stg}	Storage Temperature	-55 to +150	°C

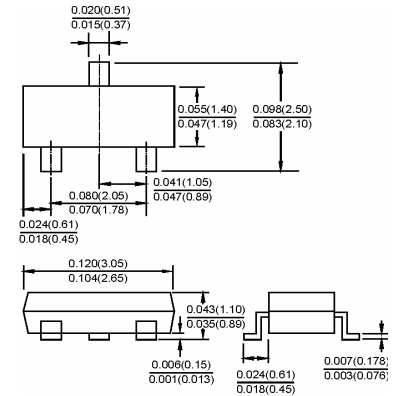

Dimensions in inches and (millimeters)

ELECTRICAL CHARACTERISTICS (T_{amb}=25°C unless otherwise specified)

Parameter	Symbol	Test conditions	MIN	MAX	UNIT
Collector-base breakdown voltage	V _{(BR)CBO}	I _C = 100μA, I _E =0	30		V
Collector-emitter breakdown voltage	V _{(BR)CEO}	I _C = 100uA, I _B =0	30		V
Collector-emitter breakdown voltage	V _{(BR)EBO}	I _E = 100μA, I _C =0	10		V
Collector cut-off current	I _{CBO} *	V _{CB} =30 V, I _E =0		0.1	μA
Emitter cut-off current	I _{EBO} *	V _{EB} = 10V, I _C =0		0.1	μA
DC current gain	h _{FE(1)} *	V _{CE} =5V, I _C = 10mA	MMBTA13 5000		
	h _{FE(2)} *	V _{CE} =5V, I _C = 100mA	MMBTA13 10000 MMBTA14 20000		
Collector-emitter saturation voltage	V _{CE(sat)} *	I _C =100mA, I _B =0.1mA		1.5	V
Base-emitter saturation voltage	V _{BE(sat)} *	I _C =100mA, I _B =0.1mA		2	V
Base-emitter voltage	V _{BE} *	V _{CE} =5V, I _C = 100mA		2.0	V
Transition frequency	f _T	V _{CE} =5V, I _C = 10mA f=100MHz	125		MHz
Collector output capacitance	C _{ob}	V _{CB} =10V, I _E =0, f=1MHz		12	pF

* Pulse Test : pulse width≤300μs,duty cycle≤2%.

Typical Characteristics

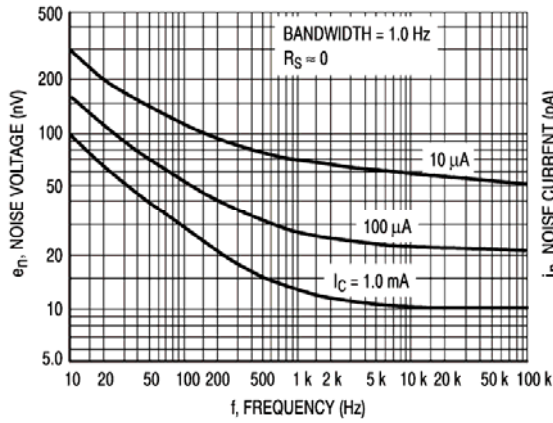

Figure 2. Noise Voltage

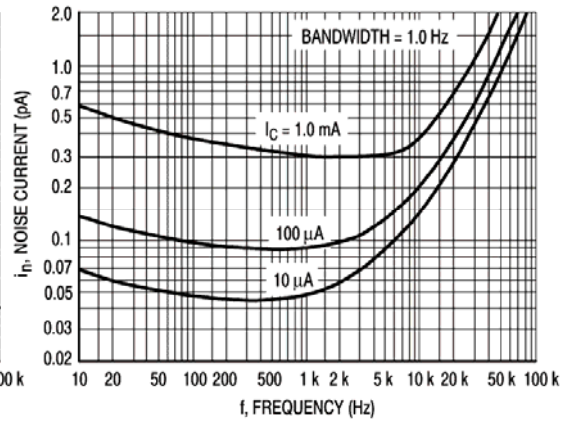

Figure 3. Noise Current

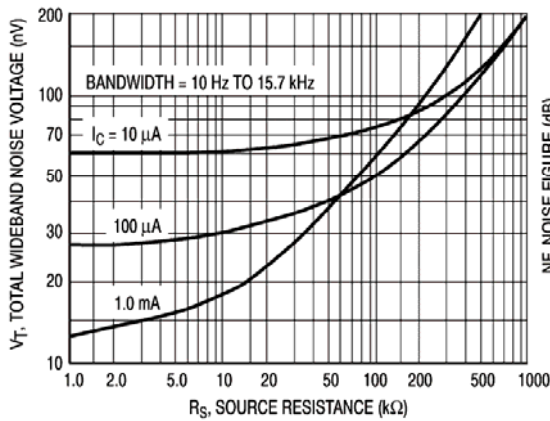

Figure 4. Total Wideband Noise Voltage

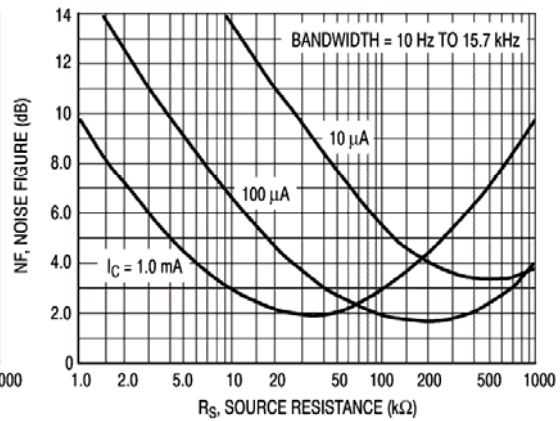

Figure 5. Wideband Noise Figure

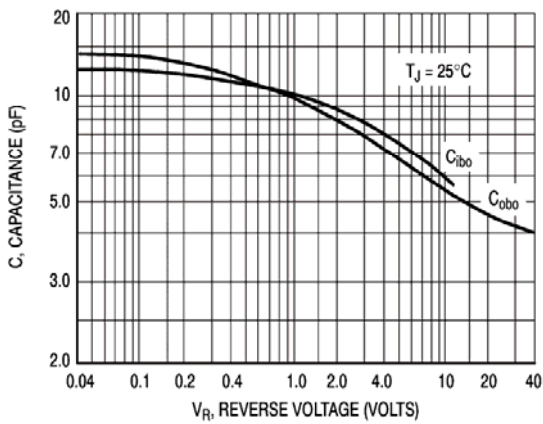

Figure 6. Capacitance

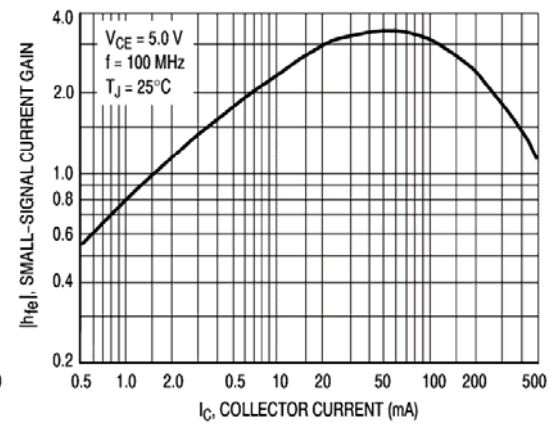

Figure 7. High Frequency Current Gain

Typical Characteristics

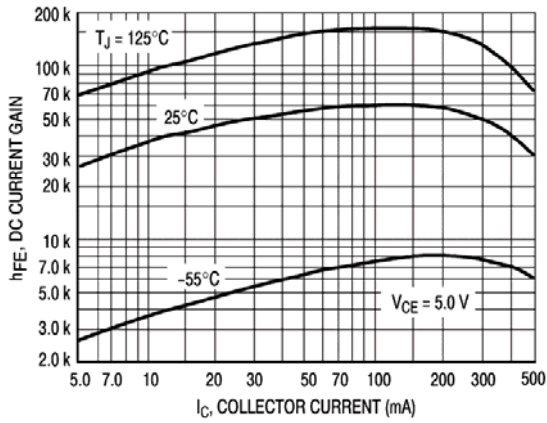

Figure 8. DC Current Gain

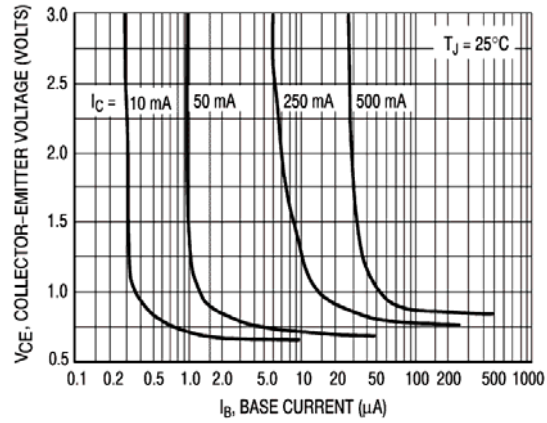

Figure 9. Collector Saturation Region

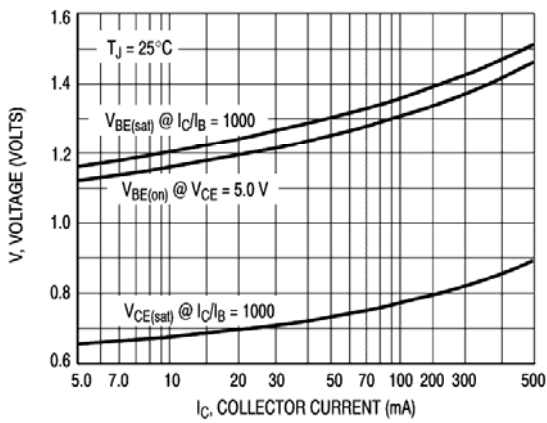

Figure 10. "On" Voltages

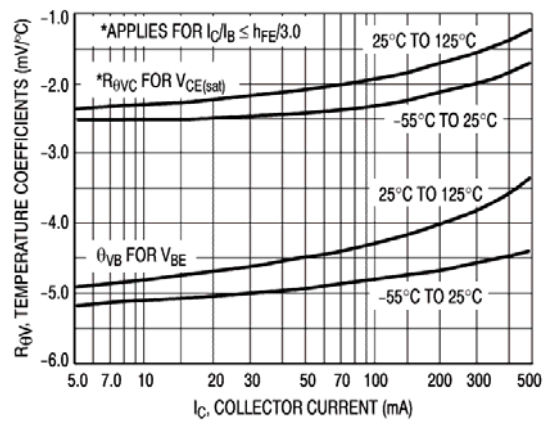

Figure 11. Temperature Coefficients

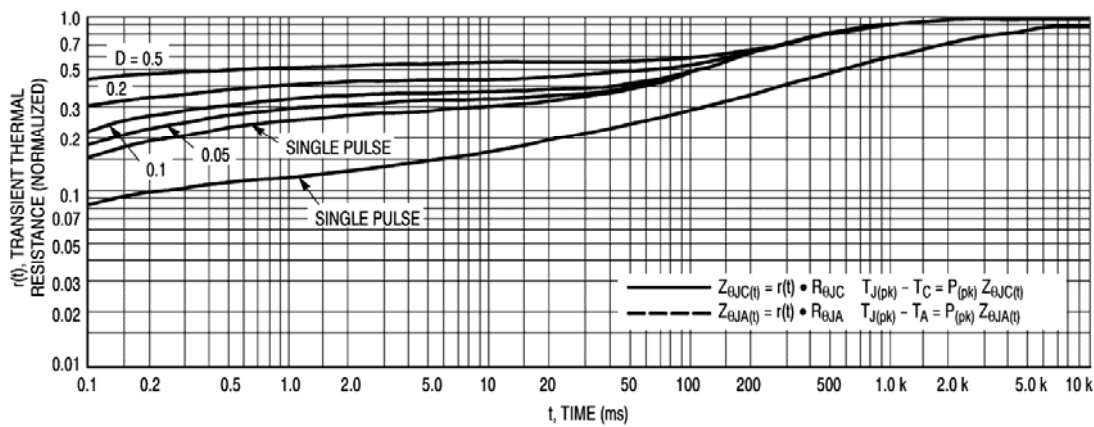

Figure 12. Thermal Response