

### Features

- Small Plastic Package
- High Switching Speed
- Low Capacitance

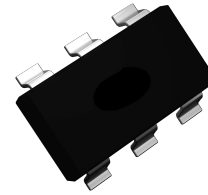

GCH' 6'

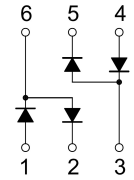

Schematic Diagram

### Absolute Maximum Ratings ( $T_A=25^\circ\text{C}$ unless otherwise specified)

Parameter	Symbol	Limit	Unit
Repetitive Peak Reverse Voltage	$V_{RRM}$	85	V
Reverse Voltage	$V_R$	75	V
Forward Current	$I_F$	150	mA
Repetitive Peak Forward Current	$I_{FRM}$	450	
Non-Repetitive Peak Forward Surge Current @ $t=8.3\text{ms}$	$I_{FSM}$	2.5	A
Power Dissipation	$P_D$	200	mW
Thermal Resistance from Junction to Ambient	$R_{\theta JA}$	625	$^\circ\text{C/W}$
Junction Temperature	$T_j$	150	$^\circ\text{C}$
Storage Temperature	$T_{STG}$	-55 to +150	

### Electrical Characteristics ( $T_A=25^\circ\text{C}$ unless otherwise specified)

Parameter	Symbol	Test Conditions	Min	Max	Unit
Reverse Voltage	$V_{(BR)}$	$I_R=100\mu\text{A}$	75	—	V
Reverse Current	$I_R$	$V_R=75\text{V}$	—	1	$\mu\text{A}$
Forward Voltage	$V_F$	$I_F=1\text{mA}$	—	0.715	V
		$I_F=10\text{mA}$	—	0.855	
		$I_F=50\text{mA}$	—	1	
		$I_F=150\text{mA}$	—	1.25	
Total Capacitance	$C_{tot}$	$V_R=0, f=1\text{MHz}$	—	1.5	pF
Reverse Recovery Time	$t_{rr}$	$I_F=I_R=10\text{mA}, I_{rr}=0.1 \times I_R, R_L=100\Omega$	—	6	ns

## Typical Characteristics Curves

Forward Characteristics

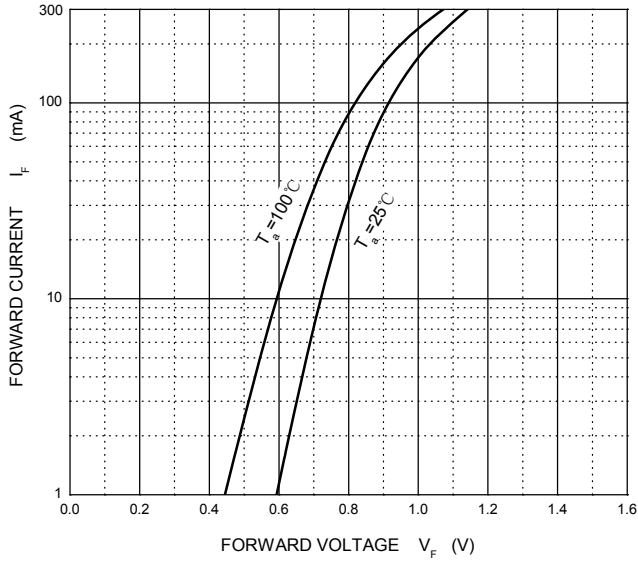

Reverse Characteristics

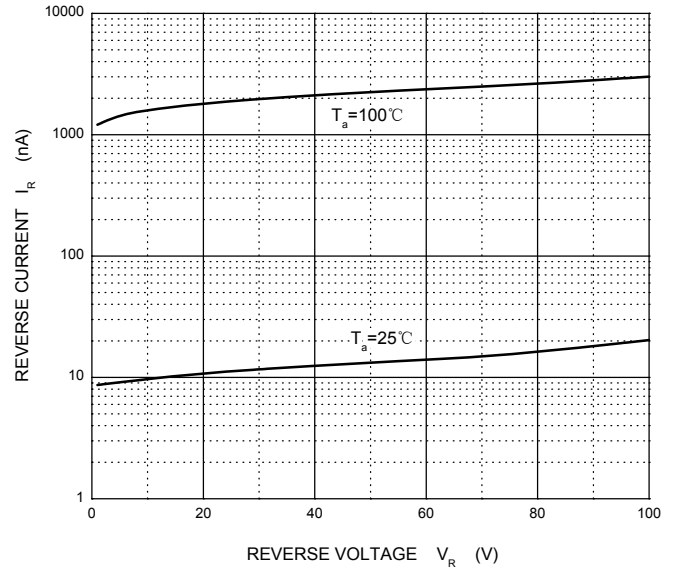

Capacitance Characteristics

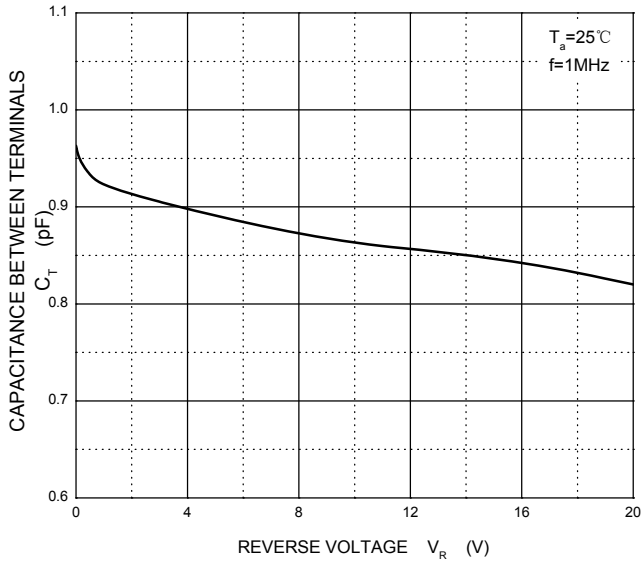

Power Derating Curve

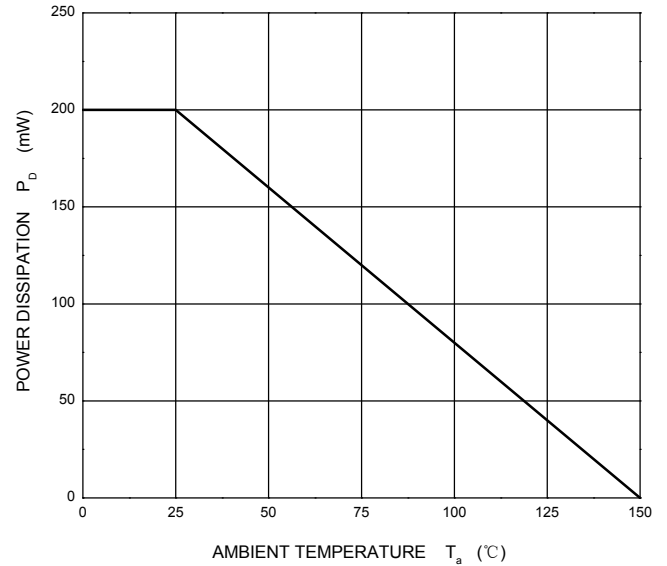

## Package Outline Dimensions SOT-363

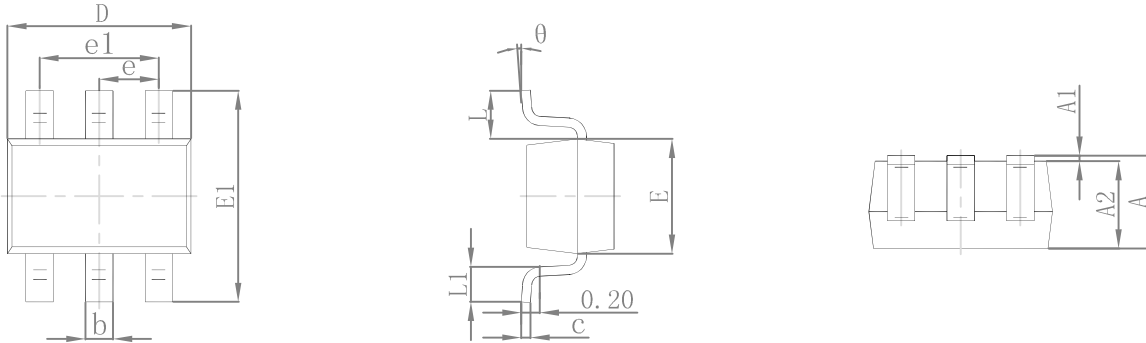

Symbol	Dimensions in Millimeters		Dimensions in Inches	
	Min	Max	Min	Max
A	0.900	1.100	0.035	0.043
A1	0.000	0.100	0.000	0.004
A2	0.900	1.000	0.035	0.039
b	0.150	0.350	0.006	0.014
c	0.100	0.150	0.004	0.006
D	2.000	2.200	0.079	0.087
E	1.150	1.350	0.045	0.053
E1	2.150	2.400	0.085	0.094
e	0.650 TYP		0.026 TYP	
e1	1.200	1.400	0.047	0.055
L	0.525 REF		0.021 REF	
L1	0.260	0.460	0.010	0.018
θ	0°	8°	0°	8°

## Suggested Pad Layout

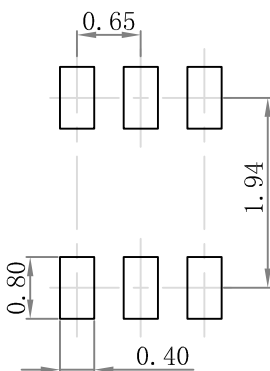

**Note:**

1. Controlling dimension: in millimeters.
2. General tolerance:  $\pm 0.05\text{mm}$ .
3. The pad layout is for reference purposes only.

## Order Information

Device	Package	Marking	Carrier	Quantity	HSF Status
GSBAV99S	SOT-363	K1	Tape & Reel	3000pcs / Reel	RoHS compliant