

Bridge Rectifiers

Features

- UL recognition, file #E313149
- High surge current capability
- Solder dip 275 °C max. 7 s, per JESD 22-B106

Typical Applications

General purpose use in AC/DC bridge full wave rectification for SMPS, lighting ballast, adapter, battery charger, home appliances, office equipment, and telecommunication applications.

Mechanical Data

- **Package:** DB
Molding compound meets UL 94 V-0 flammability rating, RoHS-compliant, Halogen free
- **Terminals:** Tin plated leads, solderable per J-STD-002 and JESD22-B102
- **Polarity:** As marked on body

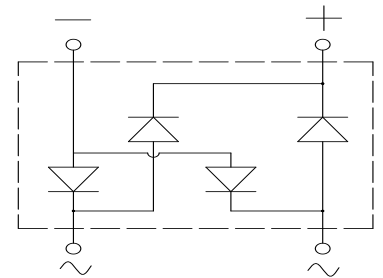
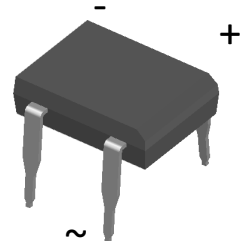

■ Maximum Ratings (T_a=25°C Unless otherwise specified)

PARAMETER	SYMBOL	UNIT	DB101	DB102	DB103	DB104	DB105	DB106	DB107
Device marking code			DB101	DB102	DB103	DB104	DB105	DB106	DB107
Repetitive peak reverse voltage	V _{RRM}	V	50	100	200	400	600	800	1000
Average rectified output current @60Hz sine wave, R-load, T _a =40°C	I _O	A	1.0						
Surge(non-repetitive)forward current @60Hz half sine wave, 1 cycle, T _j =25°C	I _{FSM}	A	30						
Current squared time @1ms≤t≤8.3ms T _j =25°C, Rating of per diode	I ² t	A ² s	3.7						
Storage temperature	T _{stg}	°C	-55 ~+150						
Junction temperature	T _j	°C	-55 ~+150						

■ Electrical Characteristics (T_a=25°C Unless otherwise specified)

PARAMETER	SYMBOL	UNIT	TEST CONDITIONS	DB101	DB102	DB103	DB104	DB105	DB106	DB107
Maximum instantaneous forward voltage drop per diode	V _F	V	I _{FM} =0.5A	1.00						
Maximum DC reverse current at rated DC blocking voltage per diode	I _{RRM}	μA	V _{RM} =V _{RRM}	5						

■ **Thermal Characteristics** ($T_a=25^\circ\text{C}$ Unless otherwise specified)

PARAMETER	SYMBOL	UNIT	DB101	DB102	DB103	DB104	DB105	DB106	DB107
Thermal Resistance	R θ J-A(1)	$^\circ\text{C/W}$	68.0						
	R θ J-L		15.0						

Note:(1)Thermal resistance from Between junction and ambient, On glass-epoxi substrate.

■ **Ordering Information (Example)**

PREFERED P/N	PACKING CODE	UNIT WEIGHT(g)	MINIIMUM PACKAGE(pcs)	INNER BOX QUANTITY(pcs)	OUTER CARTON QUANTITY(pcs)	DELIVERY MODE
DB101-DB107	B1	Approximate 0.39	50	2500	10000	Tube

■ **Characteristics (Typical)**

FIG1:Io-Ta Curve

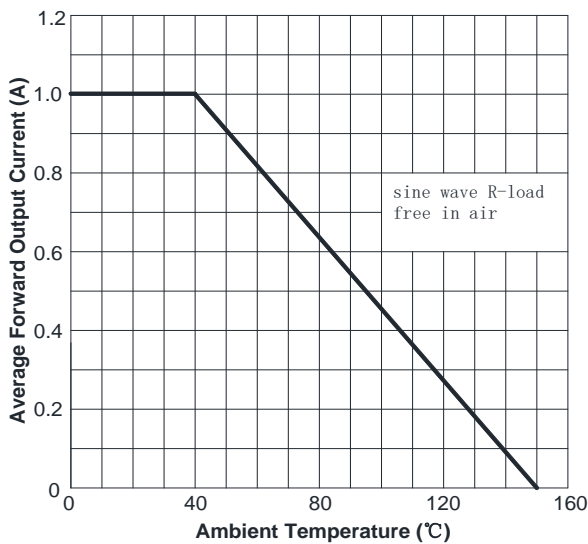

FIG2:Surge Forward Current Capability

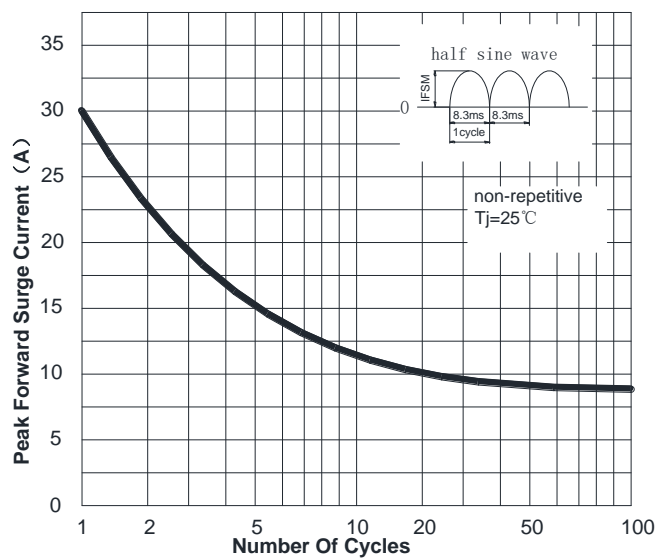

FIG3: Forward Voltage

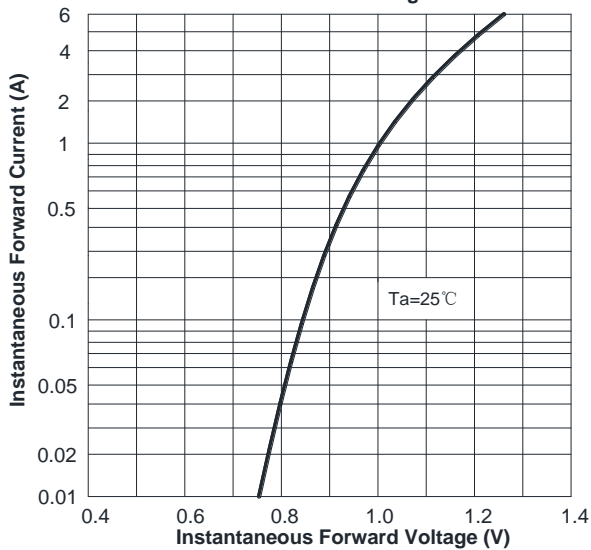
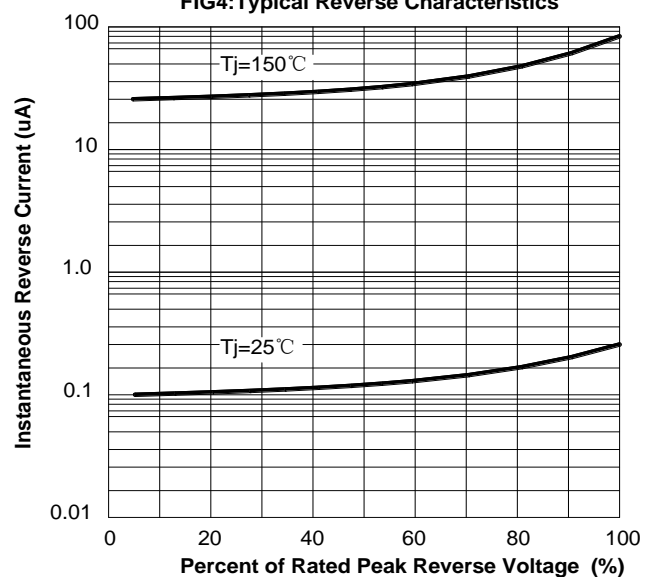
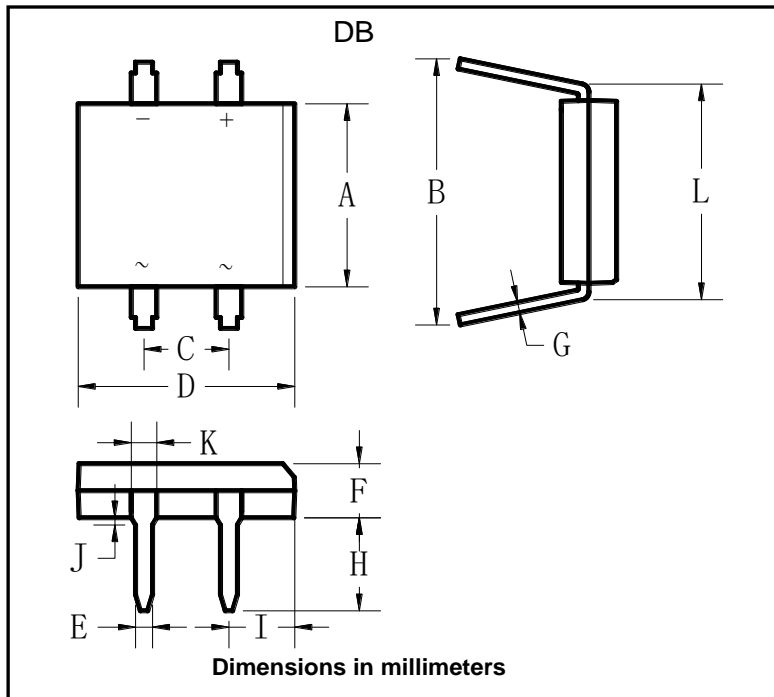

FIG4:Typical Reverse Characteristics



■ Outline Dimensions



DB		
Dim	Min	Max
A	6.20	6.50
B	7.60	8.90
C	5.00	5.20
D	8.13	8.51
E	0.46	0.58
F	2.80	3.30
G	0.22	0.33
H	3.81	4.69
I	1.39	1.90
J	1.27	2.03
K	0.89	1.14
L	7.24	8.00

Disclaimers

These materials are intended as a reference to assist our customers in the selection of the Steifpower Technology products best suited to the customer's applications, they do not convey any license under any intellectual property rights, or any other rights, belonging to Steifpower Technology or third party. Steifpower Technology assumes no responsibility for any damage, or infringement of any third-party's rights, originating in the use of any product data, diagrams, charts, programs, algorithms, or circuit application examples contained in these materials. All information contained in these materials, including product data, diagrams, charts, programs and algorithms represents information on products at the time of publication of these materials, and are subject to change by Steifpower Technology without notice due to product improvements or other reasons.

It is therefore recommended that customers contact Steifpower Technology or an authorized Steifpower Technology distributor for the latest product information before purchasing a product listed herein.

The information described here may contain technical inaccuracies or typographical errors.

Steifpower Technology assumes no responsibility for any damage, liability, or other loss arising from these inaccuracies or errors.

Please also pay attention to information published by Steifpower Technology by various means including our website home page (<http://www.steifpower.com>).

When using any or all of the information contained in these materials, including product data diagrams, charts, programs, and algorithms, please be sure to evaluate all information as a total system before making a final decision on the applicability of the information and products.

Steifpower Technology assumes no responsibility for any damage, liability or other loss resulting from the information contained herein.

The prior written approval of Steifpower Technology is necessary to reprint or reproduce in whole or in part these materials.

Please contact Steifpower Technology or an authorized distributor for further details on these materials or the products contained herein.