

Features

- Fast Switching Speed
- For General Purpose Switching
- Applications High Conductance

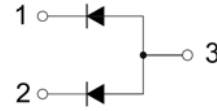

Schematic Diagram

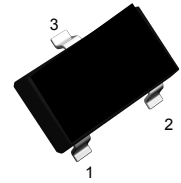

SOT-23

Absolute Maximum Ratings ($T_A=25^\circ\text{C}$ unless otherwise specified)

Parameter	Symbol	Value	Unit
Reverse Voltage	V_R	70	V
Forward Current	I_F	200	mA
Non-Repetitive Peak Forward Surge Current @ $t=8.3\text{ms}$	I_{FSM}	2.0	A
Power Dissipation	P_D	225	mW
Thermal Resistance Junction to Ambient	$R_{\theta JA}$	556	$^\circ\text{C}/\text{W}$
Junction Temperature	T_J	150	$^\circ\text{C}$
Storage Temperature Range	T_{STG}	-55 to +150	$^\circ\text{C}$

Electrical Characteristics ($T_A=25^\circ\text{C}$ unless otherwise specified)

Parameter	Symbol	Conditions	Min	Max	Unit
Reverse Breakdown Voltage	V_R	$I_R=100\mu\text{A}$	70	-	V
Forward Voltage	V_{F1}	$I_F=1\text{mA}$	-	0.715	V
	V_{F2}	$I_F=10\text{mA}$	-	0.855	V
	V_{F3}	$I_F=50\text{mA}$	-	1	V
	V_{F4}	$I_F=150\text{mA}$	-	1.25	V
Reverse Current	I_R	$V_R=70\text{V}$	-	2.5	μA
Capacitance Between Terminals	C_T	$V_R=0, f=1\text{MHz}$	-	1.5	pF
Reverse Recovery Time	t_{rr}	$I_F = I_R = 10\text{mA},$ $I_{rr} = 0.1 \times I_R, R_L = 100\Omega$	-	6	ns

Typical Characteristics Curves

Forward Characteristics

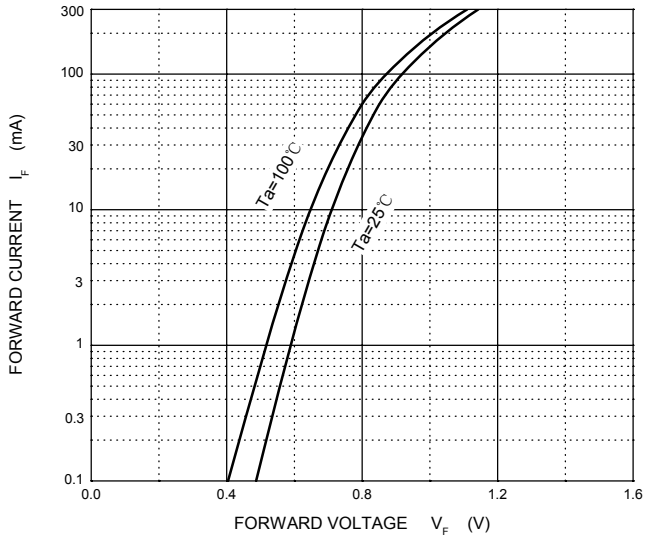

Reverse Characteristics

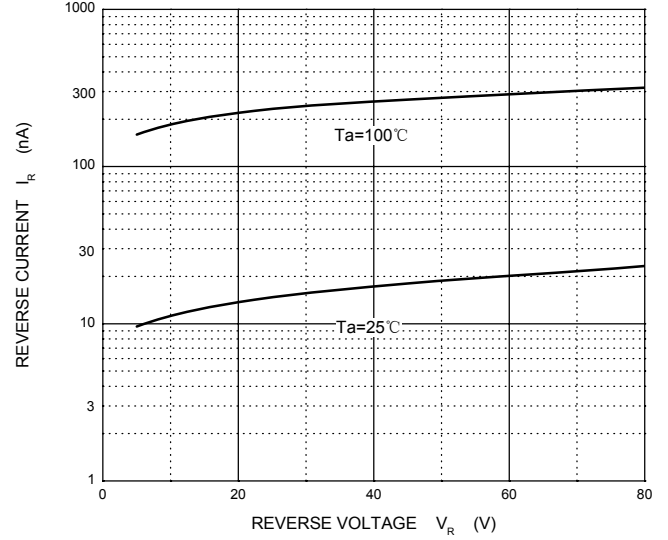

Capacitance Characteristics

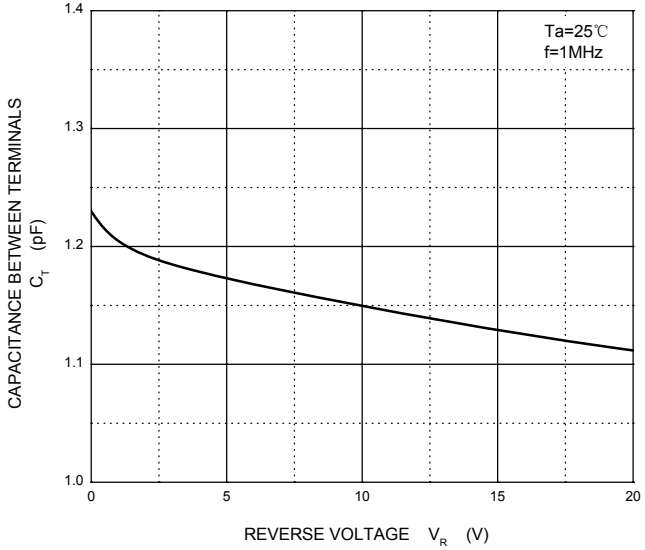

Power Derating Curve

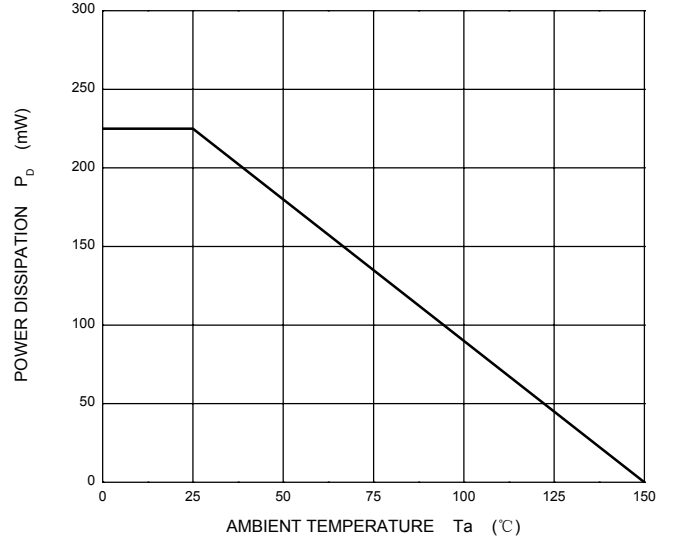

Package Outline Dimensions SOT-23

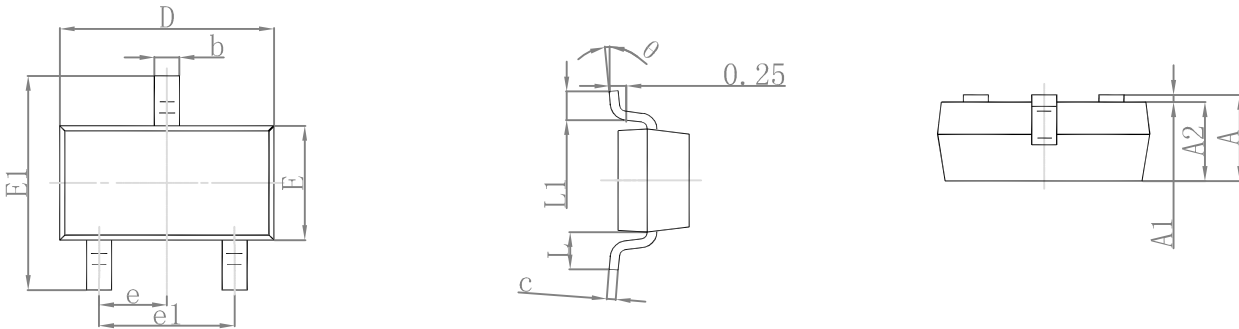

Symbol	Dimensions In Millimeters		Dimensions In Inches	
	Min	Max	Min	Max
A	0.900	1.150	0.035	0.045
A1	0.000	0.100	0.000	0.004
A2	0.900	1.050	0.035	0.041
b	0.300	0.500	0.012	0.020
c	0.080	0.150	0.003	0.006
D	2.800	3.000	0.110	0.118
E	1.200	1.400	0.047	0.055
E1	2.250	2.550	0.089	0.100
e	0.950 TYP		0.037 TYP	
e1	1.800	2.000	0.071	0.079
L	0.550 REF		0.022 REF	
L1	0.300	0.500	0.012	0.020
θ	0°	8°	0°	8°

Suggested Pad Layout

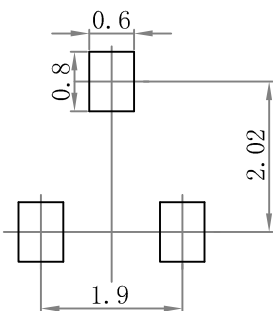

Note:
 1. Controlling dimension: in millimeters.
 2. General tolerance: $\pm 0.05\text{mm}$.
 3. The pad layout is for reference purposes only.

Order Information

Device	Package	Marking	Carrier	Quantity	HSF Status
BAW56	SOT-23	A1	Tape & Reel	3000pcs / Reel	RoHS compliant